

ROMBO
→ RELIABILITY

TIDC INDIA

Unit of Tube Investments of India Ltd.

FACTORY/ HEAD OFFICE MARKETING

Post Bag No. 11, Ambattur, Chennai - 600 053, India

Tel : +91 44 42235521 / 523 / 555

Fax : +91 44 42235556

E-mail : exports_tidc@murugappa.co.in

www.Rombochain.com

TIDC INDIA

Unit of Tube Investments of India Ltd.

FROM
TIDC INDIA

Unit of Tube Investments of India Ltd.

ROMBO[®]

→ RELIABILITY

THE COMPLETE
CHAIN COMPANY





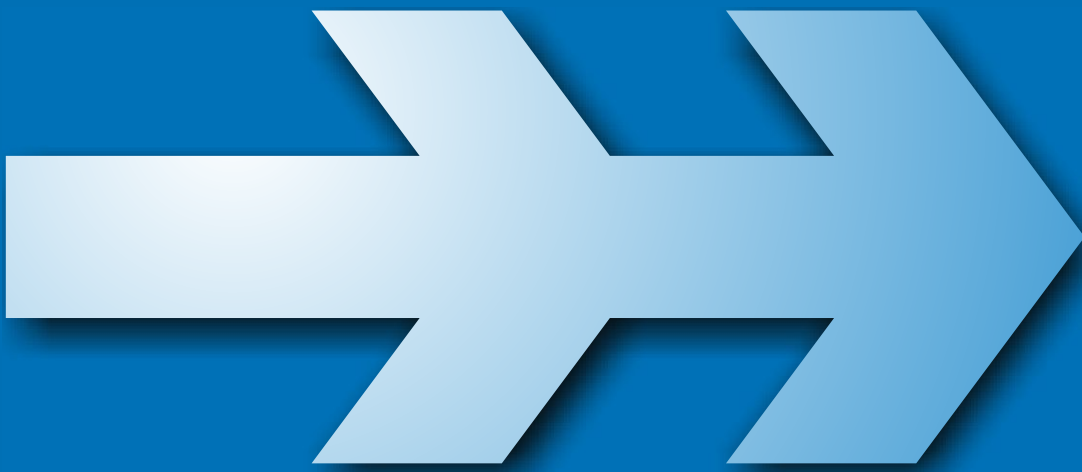

RELIABILITY



We rely on

extensive R&D exercises, to provide the insights that keep our products in step with the market.

We believe in a collaborative approach to new product development, to provide value and reduce delivery time.

We depend on the latest in design software and chain manufacturing technology.

We count on over 2,75,000 sq.ft. of factory space, to roll out our products in sufficient numbers and in keeping with stringent quality control.

We trust in a widespread sales network, to reach these products to clients in Europe, North America, the Far East, Latin America and Africa.

And that's why, our clients rely on us.



From TIDC

The complete chain company

Rombo chains are designed and manufactured by TIDC INDIA, a part of the US \$ 1 billion Murugappa Group, one of the most trusted and respected business Groups in India. A Group that is renowned for its belief in ethical business practices, innovative processes and people development.

TIDC was started in 1960, to manufacture bicycle chains and the following decades were witness to our unprecedented growth and expansion. Step by step, we've included over 1000 varieties of chains in our range. From tiller chains, leaf chains and conveyor chains to industrial power drive chains, motorcycle drive chains and engine mechanism chains, our production has grown to a gigantic 15 million metres annually.

And today, we possess the capability to meet any requirement in chains, anywhere in the world.

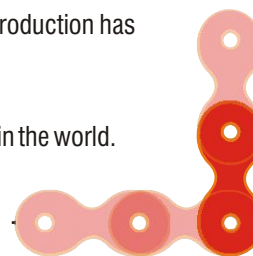

Success can be spelt with two letters. R & D

At TIDC, we owe our success to listening. Paying attention to our customers, and innovating with products that suit their needs better. Every choice with regard to size, material or method is in direct response to the needs of application engineers in the industries we serve.

TIDC engineers use Auto CAD, Solid works and Finite Element Analysis for cutting edge solutions in the design of the chains, and the manufacturing technology process is plotted out with equal care. The resulting products are comprehensively tested at our test labs, before they eventually find their way to a Rombo customer.

In collaboration with all our clients

A unique and rewarding system we follow at TIDC is what we call Collaborative Processes. Whereby our clients are actively involved in the making of custom built products. Today, 35% of our product sales are from customisations for special applications, and collaborative processes are the basis for our proven track record and quick deliveries achieved in this area.

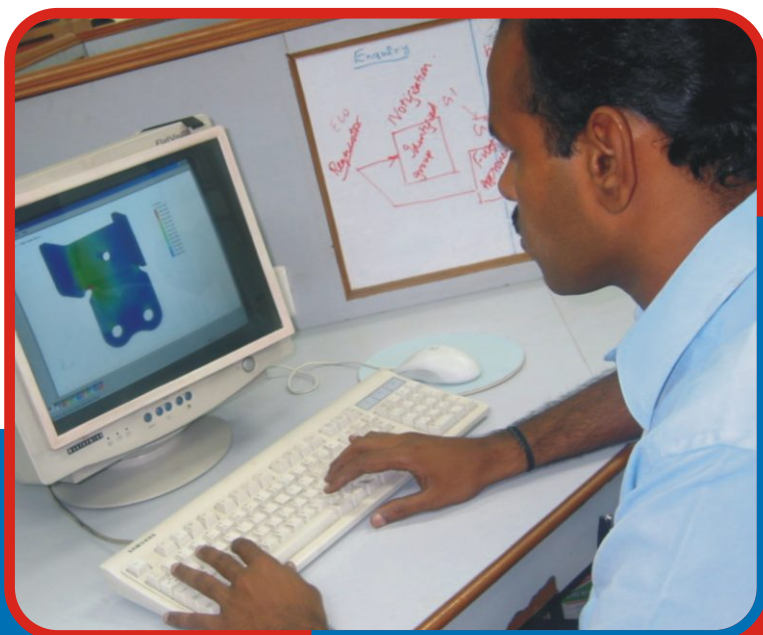



A manufacturer with rare strengths

Over the years we have developed and fine tuned immense competencies in cold working of metals, metal joining processes, metal treatment processes and development of tools, jigs and fixtures to support manufacturing technology.

Our chains get the best treatment

Our team has rich experience in heat treatment to maximise strength and life in every chain element: pins, bushing, rollers and link plates.

We deploy our specialist skills in continuous hardening operations for martensitic heat treatment. Under a completely automated atmosphere we work with high, medium and low carbon steels, alloy steels, austenitic and martensitic stainless steels etc. Some of the other treatments we offer based on customer specifications are:-

- Chain colouration - Ash, Straw, Blue, Blue Black, Brown etc. for aesthetic appeal, achieved through controlled atmosphere.
- Plates, rollers are shot peened after heat treatment thereby enhancing fatigue life. Based on application requirements we offer chromised pins that increase wear-life manifold.

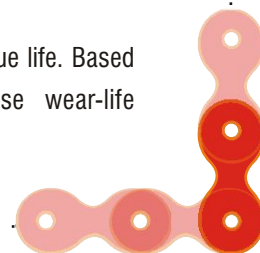

Quality, the TIES that bind everything

Total Quality Management is a governing principle at TIDC and we have our own quality system in place called 'TIES' (T. I. Excellence System) encompassing all aspects of functioning. Beginning with the design phase, purchase and inspection of raw materials, vendor management, work instructions and going on to cover all processes in manufacturing, packing and inspections before delivery.

TIES also provides for stringent procedures when it comes to traceability of products and reviews of customer feedback.

The TIES system functions by nurturing quality as an integral part in the entire value chain, and is now completely internalised by the company.

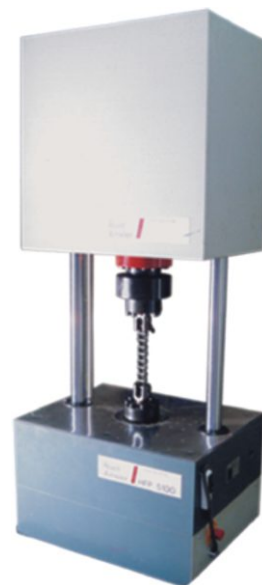

The best certifications are those that come from our clients

We are one among very few companies in the world to be certified for **API 7F** specifications by the American Petroleum Institute for oil field chains.

Our manufacturing processes right from product design to testing of finished chains conform to **ISO 9000:2000** standards and are certified by TUV of Germany. Our Motorcycle Engine Mechanism Chain and Fine Blanking Divisions as well, are certified to **TS 16949** standards by TUV of Germany.

But what gives us the most pride is, the approval and repeat orders that come to us from our clients across the world.



CONTENTS

1	STANDARD ROLLER CHAINS	
	EUROPEAN SERIES	10
	ROMBO MAX EUROPEAN SERIES	13
	AMERICAN SERIES	17
	AMERICAN HEAVY SERIES	20
	HI - LIFE AMERICAN SERIES	23
	OTHER STANDARDS	24
	STRAIGHT SIDE PLATE CHAINS - EUROPEAN SERIES	25
	STRAIGHT SIDE PLATE CHAINS - AMERICAN SERIES	27
	DOUBLE PITCH DRIVE CHAINS - AMERICAN & EUROPEAN SERIES	28
	DOUBLE PITCH CONVEYOR CHAINS - AMERICAN SERIES	29
2	ATTACHMENT CHAINS	
	SHORT PITCH A1, K1 ATTACHMENTS	30
	SHORT PITCH A2, K2 ATTACHMENTS	32
	SHORT PITCH SM1, M1 ATTACHMENTS	34
	SHORT PITCH SM2, M2 ATTACHMENTS	36
	DOUBLE PITCH A1, K1 ATTACHMENTS	37
	DOUBLE PITCH A2, K2 ATTACHMENTS	38
	WORK STANDARD ATTACHMENTS	39
3	EXTENDED PIN CHAINS	
	SHORT PITCH CHAINS	40
	DOUBLE PITCH CHAINS - AMERICAN & EUROPEAN SERIES	41
	STRAIGHT SIDE PLATE AMERICAN SERIES	42
	WORK STANDARD EXTENDED PIN CHAINS	43
4	HOLLOW PIN CHAINS	
	TYPE 1 (WITH ROLLER, WITHOUT BUSH)	44
	TYPE 2 (WITH ROLLER AND BUSH)	44
	TYPE 3 (WITH BUSH, WITHOUT ROLLERS)	45
	TYPE 4 (DOUBLE PITCH HOLLOW PIN CHAINS)	45
	TYPE 5 (WITH CARRIER ROLLERS)	46
5	ACCUMULATOR CHAINS	
	ACCUMULATOR CHAINS	47
	TOP ROLLER CHAINS	49
	SIDE ROLLER CHAINS	50
	DOUBLE PLUS CHAINS	51
6	RUBBER TOP CHAINS	52
7	SELF LUBE CHAINS	
	PLASTIC SLEEVE CHAINS	53
	ROMBO MAX SINTERED BUSH CHAINS	54

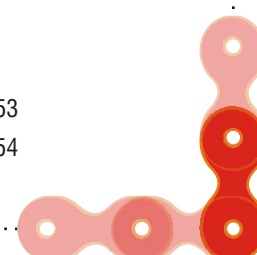

8	'O' RING CHAINS	56
9	WORK STANDARD SPECIAL CHAINS	57
10	CORROSION RESISTANT CHAINS	
	STAINLESS STEEL CHAIN EUROPEAN SERIES	58
	STAINLESS STEEL CHAIN AMERICAN SERIES	59
	STAINLESS STEEL CHAIN DOUBLE PITCH EUROPEAN SERIES	60
	STAINLESS STEEL CHAIN DOUBLE PITCH AMERICAN SERIES (DRIVE)	61
	STAINLESS STEEL CHAINS DOUBLE PITCH AMERICAN SERIES (CONVEYOR)	62
	ROMBO MAX 'ZAC' CHAINS	63
	PLATED CHAINS EUROPEAN SERIES	64
	PLATED CHAINS AMERICAN SERIES	65
11	LEAF CHAINS	
	BL SERIES	66
	ROMBO MAX BL SERIES	69
	AL SERIES	72
	LL SERIES	74
12	CONVEYOR CHAINS	
	EUROPEAN SERIES - SOLID PIN CHAINS	76
	EUROPEAN SERIES - HOLLOW PIN CHAINS	78
	METRIC SERIES (ISO) - SOLID PIN CHAINS	80
	METRIC SERIES (ISO) - HOLLOW PIN CHAINS	83
13	WORK STANDARD ENGINEERING CLASS CHAINS	84
14	AUTOMOTIVE CHAINS	
	MOTORCYCLE DRIVE CHAINS	85
	ENGINE MECHANISM CHAINS (CAM CHAINS)	87
15	TECHNICAL DATA	
	SELECTION OF ROLLER CHAIN DRIVES	89
	INSTALLATION AND MAINTENANCE OF CHAIN DRIVES	91
	LUBRICATION OF CHAIN DRIVES	92
	TROUBLE SHOOTING HINTS	93
	HORSEPOWER RATING CHART	94
	WARNING	96

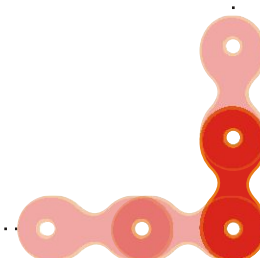

STANDARD ROLLER CHAINS

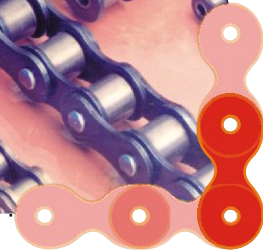

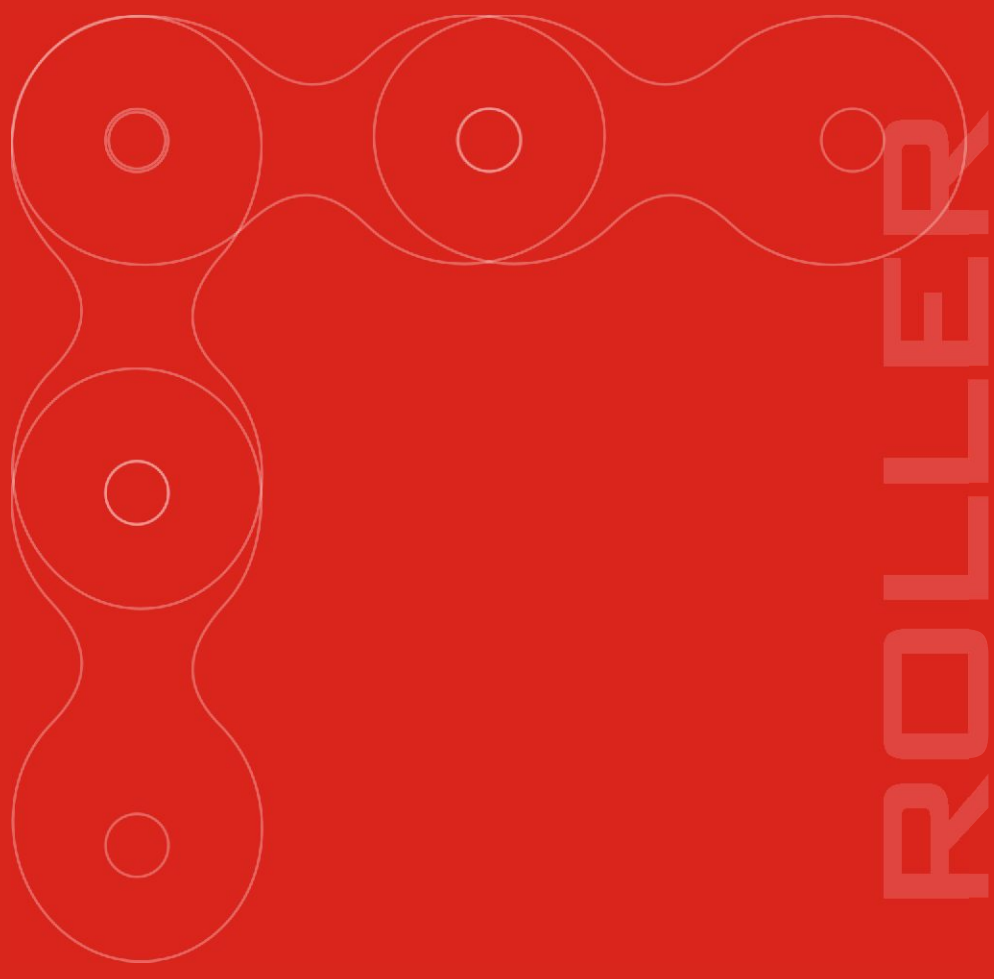

STANDARD ROLLER CHAIN

STANDARD ROLLER CHAINS

EUROPEAN SERIES



ISO 606/BS 228/DIN 8187

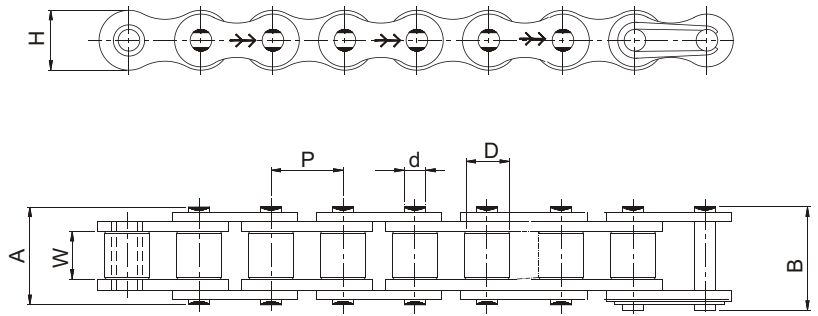

The European series of roller chains are designed for use in mechanical power transmission systems.

SINGLE STRAND

Intl. Ref. No.	ROMBO Chain No	Pitch (P)	Width between Inner Plates (W) (Min)	Roller Dia (D) (Max)	Bearing Pin Dia (d) (Max)	Plate Height (H) (Max)	Width Over Bearing Pin (A) (Max)	Width Over Joint Fasteners (B) (Max)	Projected Bearing Area (Sq. cm)	Avg. Weight Per Metre (Kg)	Tensile Strength (KN) (Min)	Tensile Strength (KN) (Avg.)	Spares Availability
04B-1	D04B 01	6.00	2.80	4.00	1.85	5.00	7.40	10.30	0.08	0.12	3.00	3.33	A,B,C,D
05B-1	D05B 01	8.00	3.00	5.00	2.31	7.10	8.60	11.70	0.11	0.18	5.00	5.90	A,B,C,D
06B-1*	D061 01	9.525	5.72	6.35	3.28	8.20	13.50	16.80	0.28	0.40	9.00	10.70	A,B,C,D
08B-1	D083 01	12.70	7.75	8.51	4.45	11.80	17.00	20.90	0.50	0.68	18.00	21.10	A,B,C,D
10B-1	D101 01	15.875	9.65	10.16	5.08	14.70	19.60	23.70	0.67	0.91	22.40	27.45	A,B,C,D
12B-1	D120 01	19.05	11.68	12.07	5.72	16.10	22.70	27.30	0.88	1.12	29.00	32.35	A,B,C,D
16B-1	D160 01	25.40	17.02	15.88	8.27	21.00	36.10	41.50	2.07	2.59	60.00	70.60	A,B,C,D
20B-1	D200 01	31.75	19.56	19.05	10.19	26.40	43.20	49.30	2.91	3.60	95.00	109.85	A,B,C,D
24B-1	D240 01	38.10	25.40	25.40	14.63	33.40	53.40	60.00	5.49	6.85	160.00	179.00	B,C,D
28B-1	D280 01	44.45	30.99	27.94	15.90	37.00	65.10	72.50	7.26	8.56	200.00	226.00	B,C,D
32B-1	D320 01	50.80	30.99	29.21	17.81	42.20	67.40	75.30	8.05	9.49	250.00	272.80	B,C,D
40B-1	D400 01	63.50	38.10	39.37	22.89	52.90	82.60	92.60	12.61	15.53	355.00	390.50	B,C,D
48B-1	D480 01	76.20	45.72	48.26	29.24	63.80	99.10	109.10	20.40	24.45	560.00	602.00	B,C,D

* Straight Side Plates

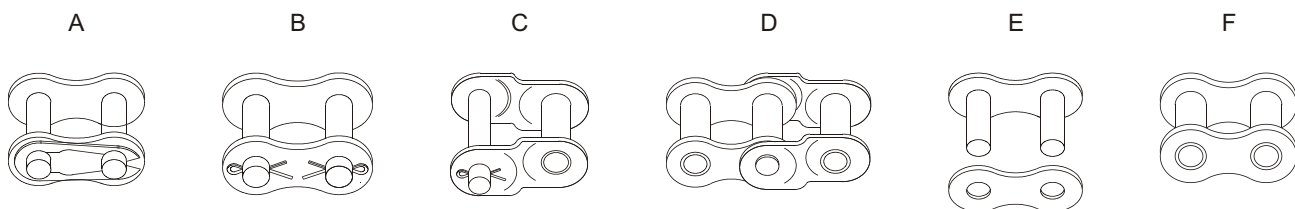

Spares E & F are available for all models

STANDARD ROLLER CHAINS

EUROPEAN SERIES



ISO 606/BS 228/DIN 8187

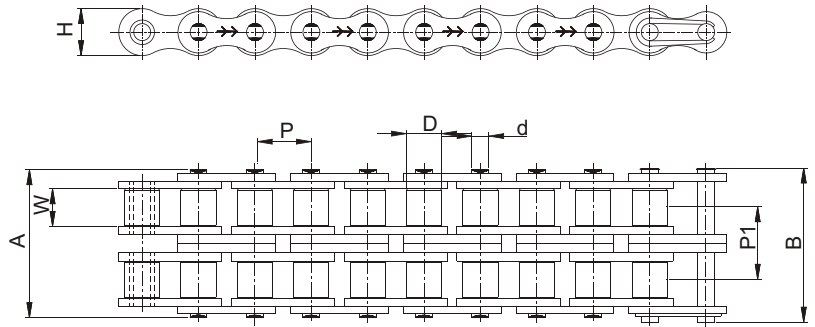

DOUBLE STRAND

Intl. Ref. No.	ROMBO Chain No.	Pitch (P)	Width between Inner Plates (W) (Min)	Roller Dia (D) (Max)	Bearing Pin Dia (d) (Max)	Plate Height (H) (Max)	Width Over Bearing Pin (A) (Max)	Width Over Joint Fasteners (B) (Max)	Transverse Pitch (P1)	Projected Bearing Area (Sq.cm)	Avg. Weight Per Metre (Kg)	Tensile Strength (KN) (Min)	Tensile Strength (KN) (Avg.)	Spares Availability
05B-2	D05B 02	8.00	3.00	5.00	2.31	7.10	14.30	17.40	5.64	0.22	0.32	7.80	8.55	A,B,C,D
06B-2*	D061 02	9.525	5.72	6.35	3.28	8.20	23.80	27.10	10.24	0.56	0.76	16.90	19.25	A,B,C,D
08B-2	D083 02	12.70	7.75	8.51	4.45	11.80	31.00	34.90	13.92	1.00	1.31	32.00	38.05	A,B,C,D
10B-2	D101 02	15.875	9.65	10.16	5.08	14.70	36.20	40.30	16.59	1.34	1.79	44.50	57.30	A,B,C,D
12B-2	D120 02	19.05	11.68	12.07	5.72	16.10	42.20	46.80	19.46	1.76	2.22	57.80	65.70	A,B,C,D
16B-2	D160 02	25.40	17.02	15.88	8.27	21.00	68.00	73.40	31.88	4.14	5.03	106.00	137.55	A,B,C,D
20B-2	D200 02	31.75	19.56	19.05	10.19	26.40	79.00	85.10	36.45	5.82	7.33	170.00	210.00	A,B,C,D
24B-2	D240 02	38.10	25.40	25.40	14.63	33.40	101.00	107.60	48.36	10.98	13.50	280.00	322.50	B,C,D
28B-2	D280 02	44.45	30.99	27.94	15.90	37.00	124.00	131.40	59.56	14.52	16.96	360.00	412.60	B,C,D
32B-2	D320 02	50.80	30.99	29.21	17.81	42.20	126.00	133.90	58.55	16.10	18.74	450.00	510.80	B,C,D
40B-2	D400 02	63.50	38.10	39.37	22.89	52.90	154.00	164.00	72.29	25.23	30.72	630.00	708.10	B,C,D
48B-2	D480 02	76.20	45.72	48.26	29.24	63.80	190.00	200.00	91.21	40.81	48.54	1000.00	1100.00	B,C,D

* Straight Side Plates

Spares E & F are available for all models

STANDARD ROLLER CHAINS

EUROPEAN SERIES



ISO 606/BS 228/DIN 8187

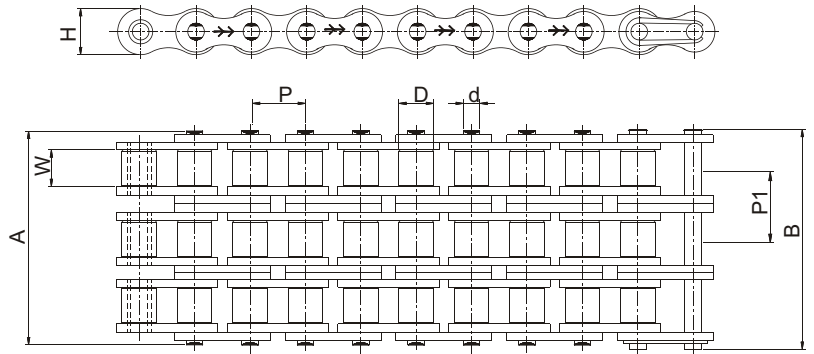

TRIPLE STRAND

Intl. Ref. No.	ROMBO Chain No.	Pitch (P)	Width between Inner Plates (W) (Min)	Roller Dia (D) (Max)	Bearing Pin Dia (d) (Max)	Plate Height (H) (Max)	Width Over Bearing Pin (A) (Max)	Width Over Joint Fasteners (B) (Max)	Transverse Pitch (P1)	Projected Bearing Area (Sq.cm)	Avg. Weight Per Metre (Kg)	Tensile Strength (KN) (Min)	Tensile Strength (KN) (Avg.)	Spares Availability
05B-3	D05B 03	8.00	3.00	5.00	2.31	7.10	19.90	23.00	5.64	0.33	0.50	11.10	12.20	A,B,C,D
06B-3*	D061 03	9.525	5.72	6.35	3.28	8.20	34.00	37.30	10.24	0.84	1.12	24.90	27.70	A,B,C,D
08B-3	D083 03	12.70	7.75	8.51	4.45	11.80	44.90	48.80	13.92	1.50	1.94	47.50	56.00	A,B,C,D
10B-3	D101 03	15.875	9.65	10.16	5.08	14.70	52.80	56.90	16.59	2.01	2.68	66.70	83.35	A,B,C,D
12B-3	D120 03	19.05	11.68	12.07	5.72	16.10	61.70	66.30	19.46	2.64	3.32	86.70	101.55	A,B,C,D
16B-3	D160 03	25.40	17.02	15.88	8.27	21.00	99.90	105.30	31.88	6.21	7.65	160.00	202.80	A,B,C,D
20B-3	D200 03	31.75	19.56	19.05	10.19	26.40	116.00	122.10	36.45	8.73	10.96	250.00	306.55	A,B,C,D
24B-3	D240 03	38.10	25.40	25.40	14.63	33.40	150.00	156.60	48.36	16.47	20.20	425.00	490.60	B,C,D
28B-3	D280 03	44.45	30.99	27.94	15.90	37.00	184.00	191.40	59.56	21.78	25.38	530.00	625.95	B,C,D
32B-3	D320 03	50.80	30.99	29.21	17.81	42.20	184.00	191.90	58.55	24.15	28.04	670.00	775.00	B,C,D
40B-3	D400 03	63.50	38.10	39.37	22.89	52.90	227.00	237.00	72.29	37.85	45.97	950.00	1088.90	B,C,D
48B-3	D480 03	76.20	45.72	48.26	29.24	63.80	281.00	291.00	91.21	61.22	72.67	1500.00	1648.10	B,C,D

* Straight Side Plates

Spares E & F are available for all models

ROLLER CHAINS

The Rombo Max Series

This special series of hi-life, special characteristic chains has been created for rugged applications, where the standard chains have always fallen short. They feature unique properties such as high breaking load, increased fatigue strength & wear life close length tolerance and more.

Rombo Max Roller Chains have been specifically developed with exceptional strength and endurance. They get their extra endurance from the inspiration in the detail of the plates, pins, bushes and rollers, manufacture to close tolerance, and assembly with care.

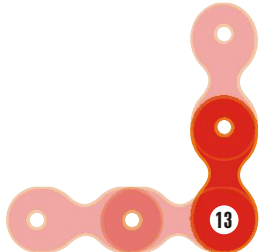
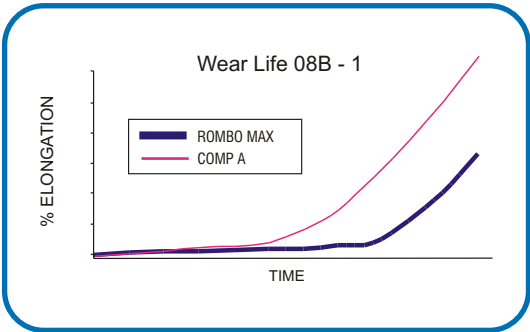
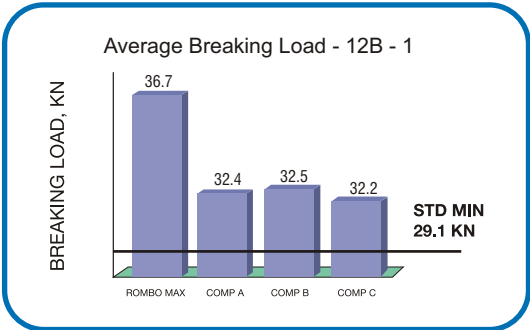

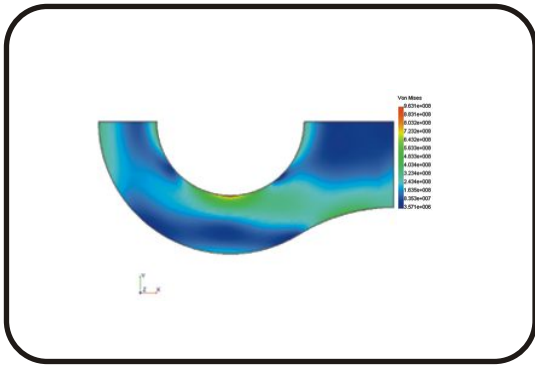

REGULAR CONTOUR

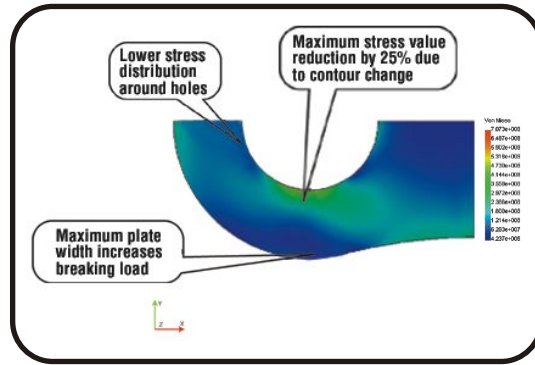

NEW CONTOUR

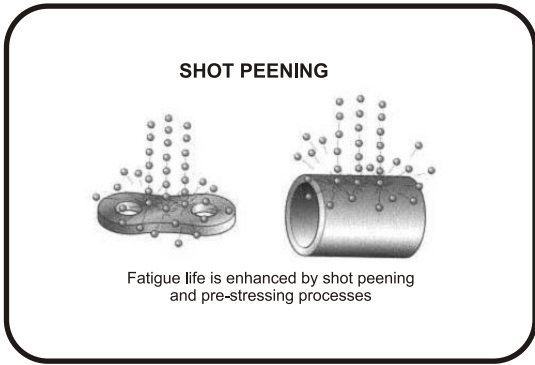

SHOT PEENED PLATES



HIGH PERFORMANCE CHAINS

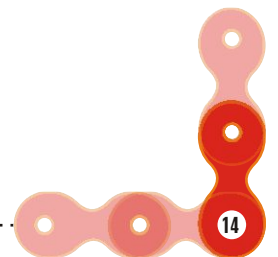

STANDARD ROLLER CHAINS

ROMBO MAX EUROPEAN SERIES

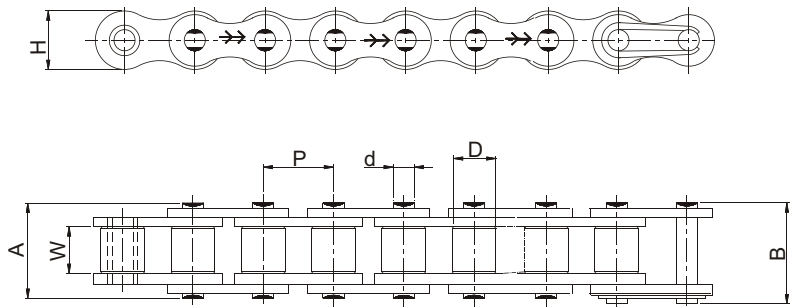

SINGLE STRAND

Intl. Ref. No.	ROMBO MAX Chain No.	Pitch (P)	Width between Inner Plates (W) (Min)	Roller Dia (D) (Max)	Plate Height (H) (Max)	Bearing Pin Dia (d) (Max)	Width Over Bearing Pin (A) (Max)	Width Over Joint Fasteners (B) (Max)	Projected Bearing Area Sq.cm	Avg. Weight Per Metre (Kg)	ROMBO MAX Tensile Strength (KN) (Min)	ROMBO MAX Tensile Strength (KN) (Avg.)	ROMBO MAX Allowable Load (KN) (Max)	Spares Availability
08B-1	Q083 01	12.70	7.75	8.51	11.81	4.45	17.00	20.90	0.50	0.74	20.79	22.66	4.50	A,B,C,D
10B-1	Q101 01	15.875	9.65	10.16	14.73	5.08	19.60	23.70	0.67	0.98	27.65	29.87	5.60	A,B,C,D
12B-1	Q120 01	19.05	11.68	12.07	16.13	5.72	22.70	27.30	0.88	1.20	33.34	36.69	7.25	A,B,C,D
16B-1	Q160 01	25.40	17.02	15.88	21.08	8.27	36.10	41.50	2.07	2.87	73.55	78.48	15.00	A,B,C,D
20B-1	Q200 01	31.75	19.56	19.05	26.42	10.19	43.20	49.30	2.91	3.85	110.82	116.74	23.75	A,B,C,D

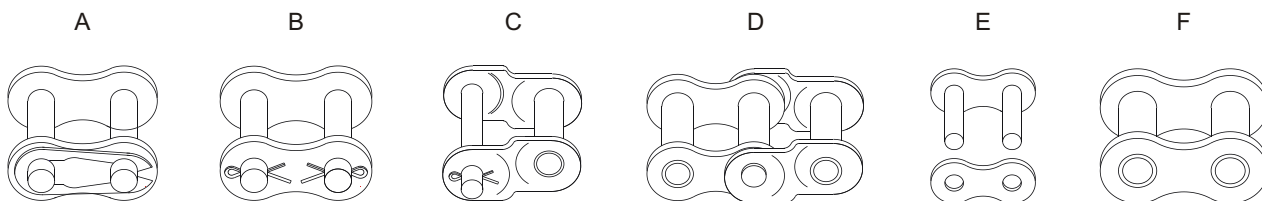

E & F are available for all models

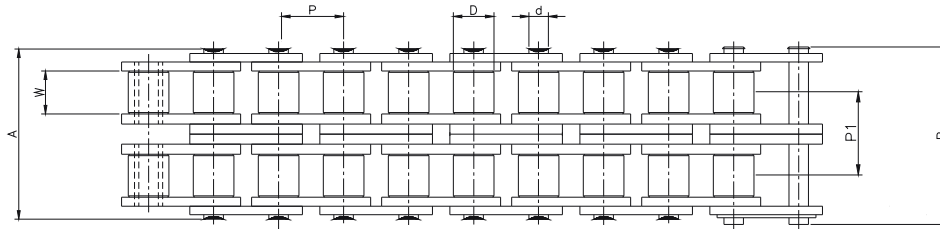
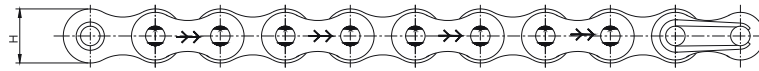

DOUBLE STRAND

Intl. Ref. No.	ROMBO MAX Chain No.	Pitch (P)	Width between Inner Plates (W) (Min)	Roller Dia (D) (Max)	Plate Height (H) (Max)	Bearing Pin Dia (d) (Max)	Width Over Bearing Pin (A) (Max)	Width Over Joint Fasteners (B) (Max)	Transverse Pitch (P1)	Avg. Weight Per Metre (Kg)	ROMBO MAX Tensile Strength (KN) (Min)	ROMBO MAX Tensile Strength (KN) (Avg.)	ROMBO MAX Allowable Load (KN) (Max)	Spares Availability
08B-2	Q083 02	12.70	7.75	8.51	11.81	4.45	31.00	34.90	13.92	1.43	37.00	40.33	8.00	A,B,C,D
10B-2	Q101 02	15.875	9.65	10.16	14.73	5.08	36.20	40.30	16.59	1.93	52.00	59.74	10.40	A,B,C,D
12B-2	Q120 02	19.05	11.68	12.07	16.13	5.72	42.20	46.80	19.46	2.38	66.69	73.38	14.50	A,B,C,D
16B-2	Q160 02	25.40	17.02	15.88	21.08	8.27	68.00	73.40	31.88	5.57	147.10	156.96	30.00	A,B,C,D
20B-2	Q200 02	31.75	19.56	19.05	26.42	10.19	79.00	85.10	36.45	7.84	200.12	210.81	42.88	A,B,C,D

TRIPLE STRAND

Intl. Ref. No.	ROMBO MAX Chain No.	Pitch (P)	Width between Inner Plates (W) (Min)	Roller Dia (D) (Max)	Plate Height (H) (Max)	Bearing Pin Dia (d) (Max)	Width Over Bearing Pin (A) (Max)	Width Over Joint Fasteners (B) (Max)	Transverse Pitch (P1)	Avg. Weight Per Metre (Kg)	ROMBO MAX Tensile Strength (KN) (Min)	ROMBO MAX Tensile Strength (KN) (Avg.)	ROMBO MAX Allowable Load (KN) (Max)	Spares Availability
08B-3	Q 083 03	12.70	7.75	8.51	11.81	4.45	44.90	48.80	13.92	2.11	54.83	60.31	11.86	A,B,C,D
10B-3	Q101 03	15.875	9.65	10.16	14.73	5.08	52.80	56.90	16.59	2.89	81.42	89.61	16.80	A,B,C,D
12B-3	Q120 03	19.05	11.68	12.07	16.13	5.72	61.70	66.30	19.46	3.56	98.10	106.00	21.75	A,B,C,D
16B-3	Q160 03	25.40	17.02	15.88	21.08	8.27	99.90	105.30	31.88	8.48	220.65	235.44	45.00	A,B,C,D
20B-3	Q200 03	31.75	19.56	19.05	26.42	10.19	116.00	122.1	36.45	11.72	291.36	306.92	65.77	A,B,C,D

E & F are available for all models

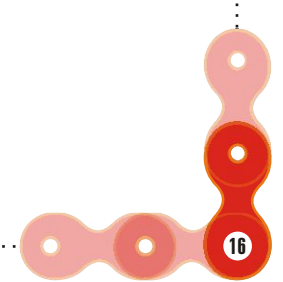

STANDARD ROLLER CHAINS

AMERICAN SERIES



ISO 606/ANSI B 29.1/DIN 8188

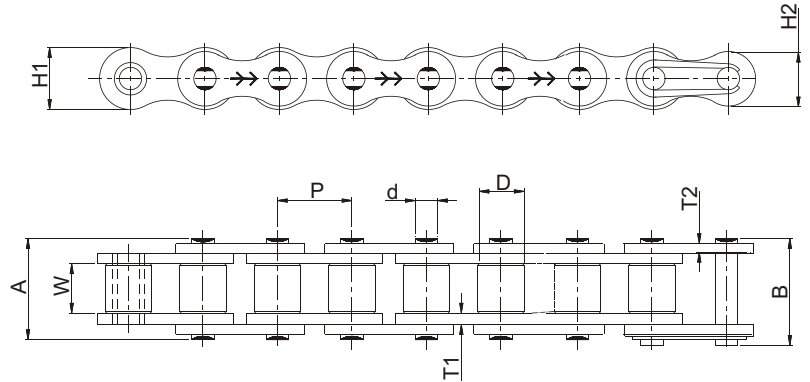

The American series of roller chains are designed for use in mechanical power transmission systems.

SINGLE STRAND

Intl. Ref. No.	ROMBO Chain No.	Pitch (P)	Width between Inner Plates (W) (Min)	Roller Dia (D) (Max)	Bearing Pin Dia (d) (Max)	Plate Height		Plate Thickness		Width Over Bearing Pin (A) (Max)	Width Over Joint Fasteners (B) (Max)	Projected Bearing Area (Sq. cm)	Avg. Weight Per Metre (Kg)	Tensile Strength (KN) (Min)	Tensile Strength (KN) (Avg.)	Spares Availability
						IP (H1) (Max)	OP (H2) (Max)	IP (T1)	OP (T2)							
25-1	B 04A 01	6.35	3.18	3.30*	2.31	5.80	5.25	0.75	0.75	7.80	9.60	0.11	0.13	3.47	3.89	A,B,C,D
35-1	B 06A 01	9.525	4.68	5.08*	3.59	8.65	7.48	1.25	1.25	12.18	13.18	0.27	0.34	7.83	10.17	A,B,C,D
40-1	D 08A 01	12.70	7.85	7.92	3.96	12.00	10.40	1.50	1.50	17.80	21.70	0.44	0.63	14.10	18.87	A,B,C,D
41-1	D 08D 01	12.70	6.25	7.77	3.60	9.55	8.26	1.25	1.25	14.80	18.70	0.33	0.43	6.67	8.27	A,B,C,D
50-1	D 102 01	15.875	9.40	10.16	5.08	15.00	13.00	2.00	2.00	21.80	25.90	0.71	1.04	22.20	30.40	A,B,C,D
60-1	D 121 01	19.05	12.58	11.91	5.94	18.00	16.60	2.39	2.39	26.90	31.50	1.04	1.52	31.80	41.70	A,B,C,D
80-1	D 161 01	25.40	15.75	15.88	7.92	24.10	20.80	3.15	3.15	33.50	38.90	1.77	2.58	56.70	72.60	A,B,C,D
100-1	D 201 01	31.75	18.90	19.05	9.53	30.10	26.00	4.00	4.00	41.10	47.20	2.59	3.85	88.50	110.40	A,B,C,D
120-1	D 241 01	38.10	25.22	22.23	11.10	36.20	31.20	4.70	4.70	50.80	57.40	3.90	5.61	127.00	144.65	B,C,D
140-1	D 281 01	44.45	25.22	25.40	12.70	42.20	36.40	5.56	5.56	54.90	62.30	4.67	7.24	172.40	190.80	B,C,D
160-1	D 321 01	50.80	31.55	28.57	14.27	48.20	41.60	6.30	6.30	65.50	73.40	6.38	9.91	226.80	253.40	B,C,D
180-1	D 361 01	57.15	35.48	35.71	17.46	54.31	46.86	7.14	7.14	73.90	83.00	9.38	13.23	280.20	300.00	B,C,D
200-1	D 401 01	63.50	37.85	39.68	19.84	60.30	52.00	7.90	7.90	80.30	90.30	10.75	16.26	353.80	388.10	B,C,D
240-1	D 481 01	76.20	47.35	47.63	23.80	72.30	62.40	8.80	8.80	95.50	105.50	15.90	23.63	520.40	524.80	B,C,D

* Bush Chain

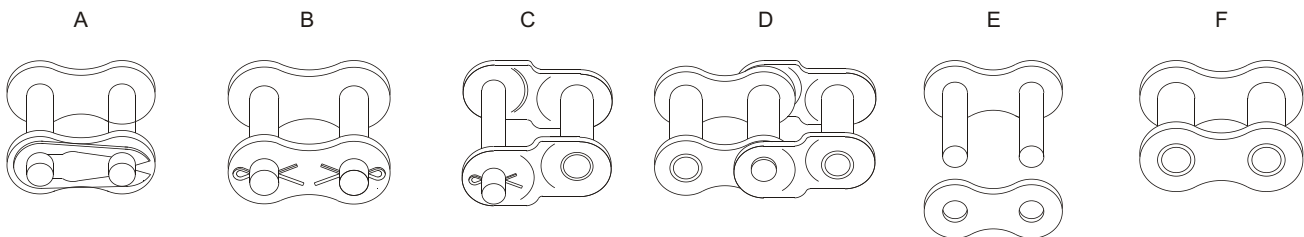

Spares E & F are available for all models

STANDARD ROLLER CHAINS

AMERICAN SERIES



ISO 606/ANSI B 29.1/DIN 8188

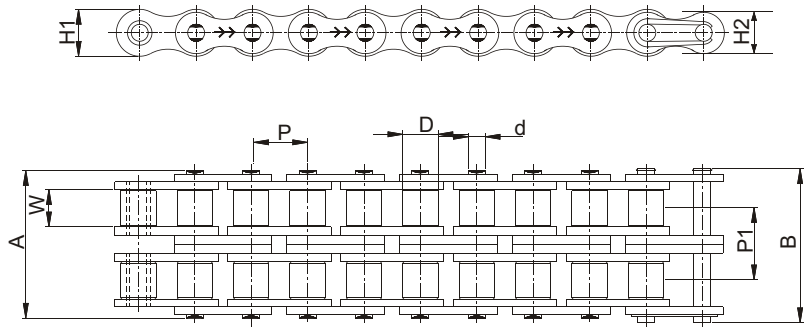

DOUBLE STRAND

Intl. Ref. No.	ROMBO Chain No.	Pitch (P)	Width between Inner Plates (W) (Min)	Roller Dia (D) (Max)	Bearing Pin Dia (d) (Max)	Plate Height		Plate Thickness		Width Over Bearing Pin (A) (Max)	Width Over Joint Fasteners (B) (Max)	Transverse Pitch (P1)	Projected Bearing Area (Sq.cm)	Avg. Weight Per Metre (Kg)	Tensile Strength (KN) (Min)	Tensile Strength (KN) (Avg.)	Spares Availability
						IP (H1) (Max)	OP (H2) (Max)	IP (T1)	OP (T2)								
35-2	B 06A 02	9.525	4.68	5.08*	3.59	8.65	7.48	1.25	1.25	24.20	27.40	10.13	0.53	0.67	15.65	20.35	A,B,C,D
40-2	D 08A 02	12.70	7.85	7.92	3.96	12.00	10.40	1.50	1.50	32.30	36.20	14.38	0.88	1.26	28.20	37.70	A,B,C,D
50-2	D 102 02	15.875	9.40	10.16	5.08	15.00	13.00	2.00	2.00	39.90	44.00	18.11	1.42	2.05	44.40	60.80	A,B,C,D
60-2	D 121 02	19.05	12.58	11.91	5.94	18.00	16.60	2.39	2.39	49.80	54.40	22.78	2.08	3.01	63.60	83.40	A,B,C,D
80-2	D 161 02	25.40	15.75	15.88	7.92	24.10	20.80	3.15	3.15	62.70	68.10	29.29	3.54	5.13	113.40	145.15	A,B,C,D
100-2	D 201 02	31.75	18.90	19.05	9.53	30.10	26.00	4.00	4.00	77.00	83.10	35.76	5.18	7.64	177.00	220.85	A,B,C,D
120-2	D 241 02	38.10	25.22	22.23	11.10	36.20	31.20	4.70	4.70	96.30	102.90	45.44	7.80	11.13	254.00	289.30	B,C,D
140-2	D 281 02	44.45	25.22	25.40	12.70	42.20	36.40	5.56	5.56	103.00	110.40	48.87	9.35	14.37	344.80	381.60	B,C,D
160-2	D 321 02	50.80	31.55	28.57	14.27	48.20	41.60	6.30	6.30	124.00	131.90	58.55	12.77	19.68	453.60	506.75	B,C,D
180-2	D 361 02	57.15	35.48	35.71	17.46	54.31	46.86	7.14	7.14	140.00	149.90	65.84	18.76	26.46	560.50	580.00	B,C,D
200-2	D 401 02	63.50	37.85	39.68	19.84	60.30	52.00	7.90	7.90	151.00	161.00	71.55	21.50	32.83	707.60	776.15	B,C,D
240-2	D 481 02	76.20	47.35	47.63	23.80	72.30	62.40	8.80	8.80	183.00	193.00	87.83	31.80	46.72	1040.80	1064.50	B,C,D

* Bush Chain

Spares E & F are available for all models

STANDARD ROLLER CHAINS

AMERICAN SERIES



ISO 606/ANSI B 29.1/DIN 8188

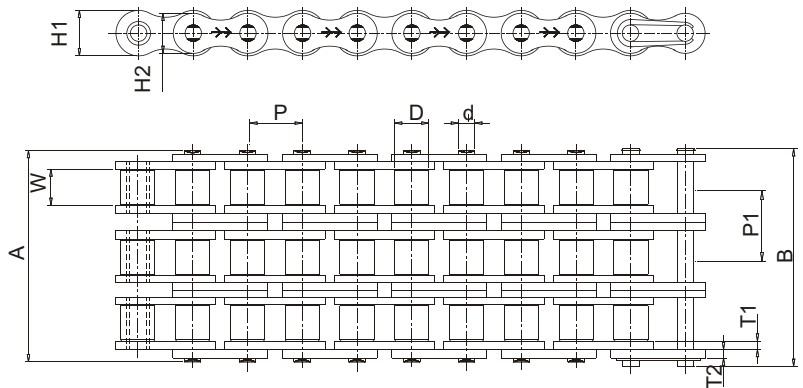

TRIPLE STRAND

Intl. Ref No.	ROMBO Chain No.	Pitch (P)	Width between Inner Plates (W) (Min)	Roller Dia (D) (Max)	Bearing Pin Dia (d) (Max)	Plate Height		Plate Thickness		Width Over Bearing Pin (A) (Max)	Width Over Joint Fasteners (B) (Max)	Transverse Pitch (P1)	Projected Bearing Area Sq.cm	Avg. Weight Per Metre (Kg)	Tensile Strength (KN) (Min)	Tensile Strength (KN) (Avg.)	Spares Availability
						IP (H1) (Max)	OP (H2) (Max)	IP (T1)	OP (T2)								
35-3	B 06A 03	9.525	4.68	5.08*	3.59	8.65	7.48	1.25	1.25	34.30	37.50	10.13	0.80	0.99	23.48	30.52	A,B,C,D
40-3	D 08A 03	12.70	7.85	7.92	3.96	12.00	10.40	1.50	1.50	46.70	50.60	14.38	1.32	1.98	42.30	56.60	A,B,C,D
50-3	D 102 03	15.875	9.40	10.16	5.08	15.00	13.00	2.00	2.00	57.90	62.00	18.11	2.13	3.06	66.60	82.50	A,B,C,D
60-3	D 121 03	19.05	12.58	11.91	5.94	18.00	16.60	2.39	2.39	72.60	77.20	22.78	3.12	4.50	95.40	120.10	A,B,C,D
80-3	D 161 03	25.40	15.75	15.88	7.92	24.10	20.80	3.15	3.15	91.70	97.10	29.29	5.31	7.67	170.10	201.95	A,B,C,D
100-3	D 201 03	31.75	18.90	19.05	9.53	30.10	26.00	4.00	4.00	113.00	119.10	35.76	7.77	11.43	265.50	313.90	A,B,C,D
120-3	D 241 03	38.10	25.22	22.23	11.10	36.20	31.20	4.70	4.70	141.03	147.60	45.44	11.70	16.67	381.00	433.95	B,C,D
140-3	D 281 03	44.45	25.22	25.40	12.70	42.20	36.40	5.56	5.56	152.00	159.40	48.87	14.03	21.51	517.20	583.45	B,C,D
160-3	D 321 03	50.80	31.55	28.57	14.27	48.20	41.60	6.30	6.30	182.00	189.90	58.55	19.16	29.45	680.40	760.15	B,C,D
180-3	D 361 03	57.15	35.48	35.71	17.46	54.31	46.86	7.14	7.14	206.00	215.10	65.84	28.14	39.66	840.70	855.00	B,C,D
200-3	D 401 03	63.50	37.85	39.68	19.84	60.30	52.00	7.90	7.90	223.00	233.00	71.55	32.26	48.28	1061.40	1164.25	B,C,D
240-3	D 481 03	76.20	47.35	47.63	23.80	72.30	62.40	8.80	8.80	271.00	281.00	87.83	47.71	69.77	1561.20	1577.75	B,C,D

* Bush Chain

Spares E & F are available for all models

STANDARD ROLLER CHAINS

AMERICAN HEAVY SERIES



ANSI B 29.1

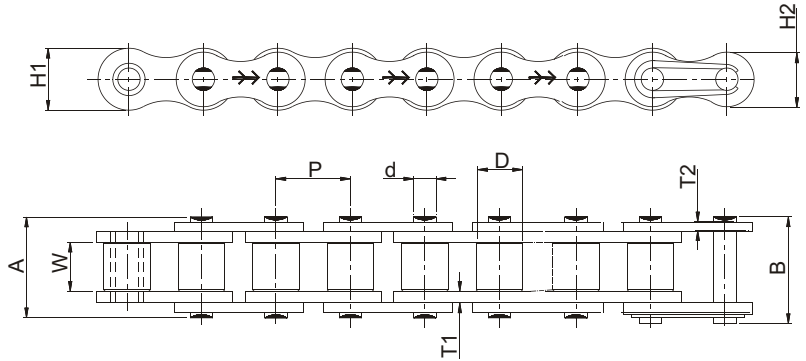

The American Heavy series roller chains are designed using link plates from the next higher size. The thicker link plates provide increased fatigue resistance and are used in drives subjected to heavy shock loads, multiple stops or reversing.

SINGLE STRAND

Intl. Ref. No.	ROMBO Chain No.	Pitch (P)	Width between Inner Plates (W) (Min)	Roller Dia (D) (Max)	Bearing Pin Dia (d) (Max)	Plate Height		Plate Thickness		Width Over Bearing Pin (A) (Max)	Width Over Joint Fasteners (B) (Max)	Projected Bearing Area Sq.cm	Avg. Weight Per Metre (Kg)	Tensile Strength (KN) (Min)	Tensile Strength (KN) (Avg.)	Spares Availability
						IP (H1) (Max)	OP (H2) (Max)	IP (T1)	OP (T2)							
60H-1	D122 01	19.05	12.58	11.91	5.94	18.00	14.88	3.15	3.15	31.20	35.80	1.14	1.81	31.27	42.15	A,B,C,D
80H-1	D162 01	25.40	15.75	15.88	7.94	24.10	20.80	4.00	4.00	38.00	43.40	1.89	3.00	55.60	72.60	A,B,C,D
100H-1	D202 01	31.75	18.90	19.05	9.54	30.10	26.00	4.70	4.70	45.40	51.50	2.75	4.38	86.87	110.40	B,C,D
120H-1	D242 01	38.10	25.22	22.23	11.11	36.20	31.20	5.56	5.56	55.10	61.70	4.10	6.61	125.10	144.65	B,C,D
140H-1	D282 01	44.45	25.22	25.40	12.71	42.20	36.40	6.30	6.30	60.40	67.80	4.67	8.33	170.27	190.80	B,C,D
160H-1	D322 01	50.80	31.55	28.57	14.29	48.20	41.60	7.14	7.14	70.00	77.90	6.38	10.88	222.40	253.40	B,C,D
200H-1	D402 01	63.50	37.85	39.67	19.85	60.30	52.00	8.80	8.80	93.10	103.30	10.75	20.65	347.50	388.10	B,C,D

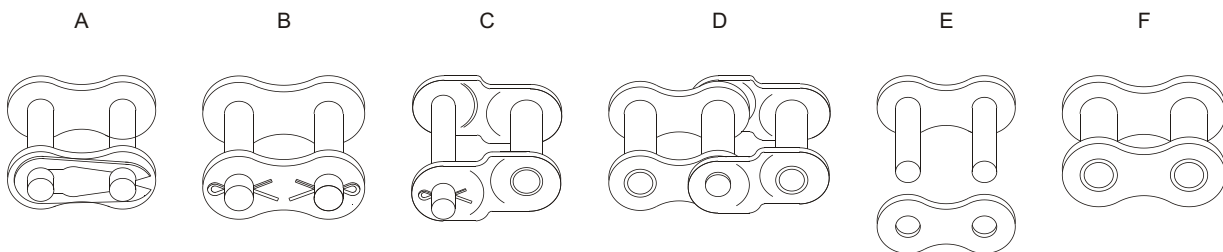

Spares E & F are available for all models

STANDARD ROLLER CHAINS

AMERICAN HEAVY SERIES



ANSI B 29.1

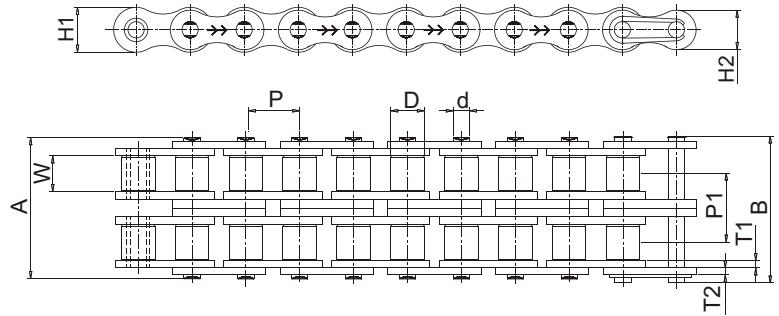

DOUBLE STRAND

Intl. Ref. No.	ROMBO Chain No.	Pitch (P)	Width between Inner Plates (W) (Min)	Roller Dia (D) (Max)	Bearing Pin Dia (d) (Max)	Plate Height		Plate Thickness		Width Over Bearing Pin (A) (Max)	Width Over Joint Fasteners (B) (Max)	Transverse Pitch (P1)	Projected Bearing Area (Sq.cm)	Avg. Weight Per Metre (Kg)	Tensile Strength (KN) (Min)	Tensile Strength (KN) (Avg.)	Spares Availability
						IP (H1) (Max)	OP (H2) (Max)	IP (T1)	OP (T2)								
60H-2	D122 02	19.05	12.58	11.91	5.94	18.00	14.88	3.15	3.15	56.10	60.70	26.11	2.27	3.71	62.54	84.43	A,B,C,D
80H-2	D 162 02	25.40	15.75	15.88	7.94	24.10	20.80	4.00	4.00	70.50	75.90	32.59	3.79	5.93	111.20	145.25	A,B,C,D
100H-2	D 202 02	31.75	18.90	19.05	9.54	30.10	26.00	4.70	4.70	84.00	90.10	39.09	5.50	8.67	173.74	220.85	B,C,D
120H-2	D 242 02	38.10	25.22	22.23	11.11	36.20	31.20	5.56	5.56	103.80	110.40	48.87	8.20	13.13	250.20	289.30	B,C,D
140H-2	D 282 02	44.45	25.22	25.40	12.71	42.20	36.40	6.30	6.30	112.20	119.60	52.20	10.40	16.52	340.54	381.60	B,C,D
160H-2	D 322 02	50.80	31.55	28.57	14.29	48.20	41.60	7.14	7.14	132.00	139.90	61.90	14.20	21.32	444.80	506.75	B,C,D
200H-2	D 402 02	63.50	37.85	39.67	19.85	60.30	52.00	8.80	8.80	170.60	180.80	78.31	24.34	39.26	695.00	776.15	B,C,D

Spares E & F are available for all models

STANDARD ROLLER CHAINS

AMERICAN HEAVY SERIES



ANSI B 29.1

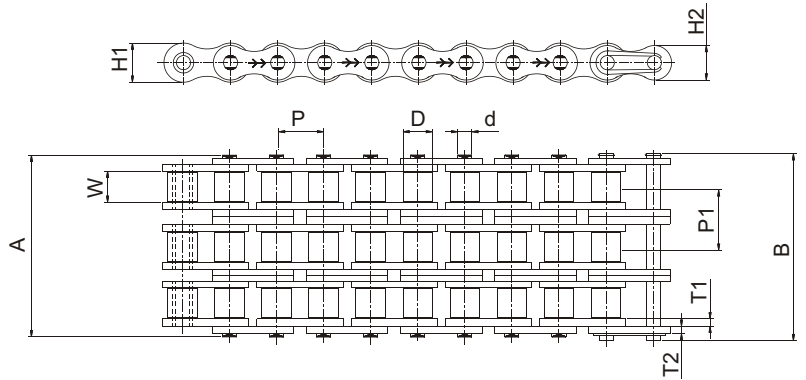

TRIPLE STRAND

Intl. Ref. No.	ROMBO Chain No.	Pitch (P)	Width between Inner Plates (W) (Min)	Roller Dia (D) (Max)	Bearing Pin Dia (d) (Max)	Plate Height		Plate Thickness		Width Over Bearing Pin (A) (Max)	Width Over Joint Fasteners (B) (Max)	Transverse Pitch (P1)	Projected Bearing Area (Sq.cm)	Avg. Weight Per Metre (Kg)	Tensile Strength (KN) (Min)	Tensile Strength (KN) (Avg.)	Spares Availability
						IP (H1) (Max)	OP (H2) (Max)	IP (T1)	OP (T2)								
60H-3	D122 03	19.05	12.58	11.91	5.94	18.00	14.88	3.15	3.15	82.20	86.80	26.11	3.41	5.52	93.81	123.85	A,B,C,D
80H-3	D 162 03	25.40	15.75	15.88	7.94	24.10	20.80	4.00	4.00	103.30	108.70	32.59	5.68	8.86	166.80	206.80	A,B,C,D
100H-3	D 202 03	31.75	18.90	19.05	9.54	30.10	26.00	4.70	4.70	123.40	129.50	39.09	8.25	12.96	260.61	313.90	B,C,D
120H-3	D 242 03	38.10	25.22	22.23	11.11	36.20	31.20	5.56	5.56	152.40	159.00	48.87	12.30	19.64	375.30	433.95	B,C,D
140H-3	D 282 03	44.45	25.22	25.40	12.71	42.20	36.40	6.30	6.30	164.30	171.70	52.20	15.64	24.73	510.81	583.45	B,C,D
160H-3	D 322 03	50.80	31.55	28.57	14.29	48.20	41.60	7.14	7.14	193.70	201.60	61.90	21.30	31.77	667.20	760.15	B,C,D
200H-3	D 402 03	63.50	37.85	39.67	19.85	60.30	52.00	8.80	8.80	252.60	262.80	78.31	36.51	60.79	1042.50	1164.25	B,C,D

Spares E & F are available for all models

STANDARD ROLLER CHAINS

HI - LIFE CHAINS - AMERICAN HEAVY SERIES

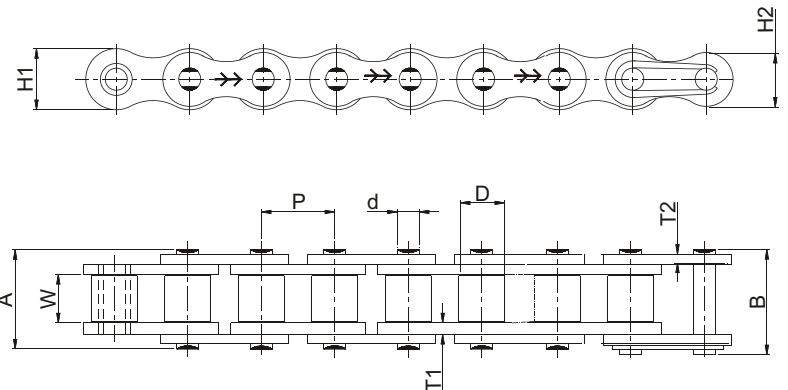

The American Heavy Series of Roller Chains are designed using link plates from the next higher size. The thicker link plates provide increased fatigue resistance and are used in drives subjected to heavy shock loads, multiple stops or reversing.

SINGLE STRAND

Intl. Ref. No.	ROMBO Chain No.	Pitch (P)	Width Between Inner Plates (W) (Min)	Roller Dia (D) (Max)	Plate Height		Plate Thickness		Bearing Pin Dia (d) (Max)	Width Over Bearing Pin (A) (Max)	Width Over Joint Fasteners (B) (Max)	Projected Bearing Area (Sq.cm)	Avg. Pound Per Feet (Lb/Ft)	Tensile Strength (KN) (Min)	Spares Availability
					IP H1 (Max)	OP H2 (Max)	IP T1 (Max)	OP T2 (Max)							
60H-1	60MHV	19.05	12.58	11.91	18.00	14.88	3.15	3.15	5.94	31.20	35.80	1.14	13.70	31.27	A,B,C,D
80H-1	80MHV	25.40	15.75	15.88	24.10	20.80	4.00	4.00	7.94	38.00	43.40	1.89	23.25	55.60	A,B,C,D
100H-1	100MHV	31.75	18.90	19.05	30.10	26.00	4.70	4.70	9.54	45.40	51.50	2.75	33.70	86.87	B,C,D
120H-1	120MHV	38.10	25.22	22.23	36.20	31.20	5.56	5.56	11.11	55.10	61.70	4.10	47.84	125.10	B,C,D
140H-1	140MHV	44.45	25.22	25.40	42.20	36.40	6.30	6.30	12.71	60.40	67.80	4.67	61.75	170.27	B,C,D
160H-1	160MHV	50.80	31.55	28.57	48.20	41.60	7.14	7.14	14.29	70.00	77.90	6.38	79.98	222.40	B,C,D
200H-1	200MHV	63.50	37.85	39.67	60.30	52.00	8.80	8.80	19.85	93.10	103.30	10.75	131.86	347.50	B,C,D

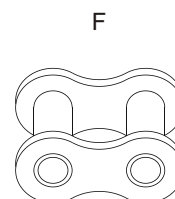
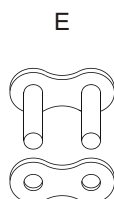
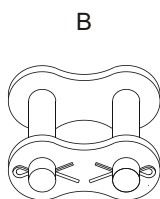

Note : We do not recommend use of offset links and spring clip type Connecting Links (A, C & D)

STANDARD ROLLER CHAINS



OTHER STANDARDS

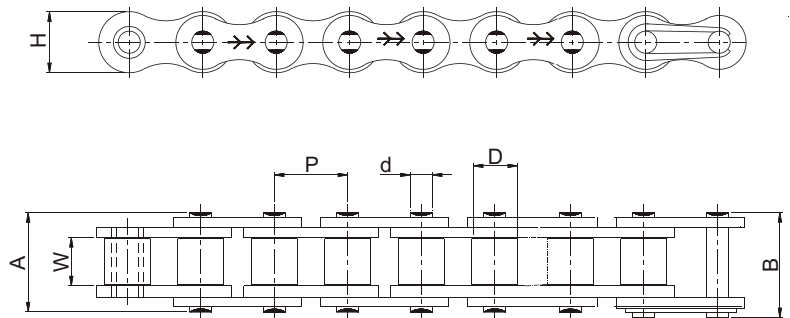

Intl. Ref. No.	ROMBO Chain No.	Pitch (P)	Width between Inner Plates (W) (Min)	Roller Dia (D) (Max)	Plate Height (H) (Max)	Bearing Pin Dia (D) (Max)	Width Over Bearing Pin (A) (Max)	Width Over Joint Fasteners (B) (Max)	Avg. Weight Per Metre (kg)	Tensile Strength (KN) (Min)
081	D08001	12.70	3.30	7.75	9.55	3.64	9.75	11.11	0.28	8.00
-	D08101	12.70	4.88	7.75	9.55	3.63	11.70	12.75	0.34	8.00
08MA	D08201	12.70	5.21	8.51	11.65	4.47	14.23	16.00	0.59	17.85
083	D08G01	12.70	4.88	7.75	10.30	4.08	12.35	13.85	0.42	12.01
J 415 F	D08M01	12.70	5.01	7.75	10.00	4.08	14.35	15.45	0.49	15.69
10MA	D10001	15.875	6.48	10.16	14.56	5.08	15.55	17.15	0.78	22.26
-	*D12301	19.05	12.72	14.24	18.80	7.92	31.40	-	2.65	58.85
12BH	D12H 01	19.05	11.68	11.91	15.90	6.06	24.75	26.65	1.39	39.25
-	D12601	19.05	9.40	11.91	18.04	5.94	22.30	23.75	1.41	31.19
-	*D14001	22.225	14.28	15.60	23.58	7.92	36.25	-	3.57	88.26
-	D160010005	25.40	35.00	15.88	20.60	8.27	53.75	55.55	3.66	60.02
-	D160010011	25.40	13.05	15.75	20.60	8.14	30.10	36.50	2.57	60.02
-	D560010001	88.90	53.34	53.98	80.20	34.32	117.80	130.00	172.54	980.67
-	SP1729	58.34	21.30	18.26	26.50	10.19	40.85	44.50	2.48	44.62

* STRAIGHT CONTOUR CHAINS

Note : Wherever international reference is not indicated models have been developed for specific requirements.

STANDARD ROLLER CHAINS

STRAIGHT SIDE PLATE CHAINS - EUROPEAN SERIES

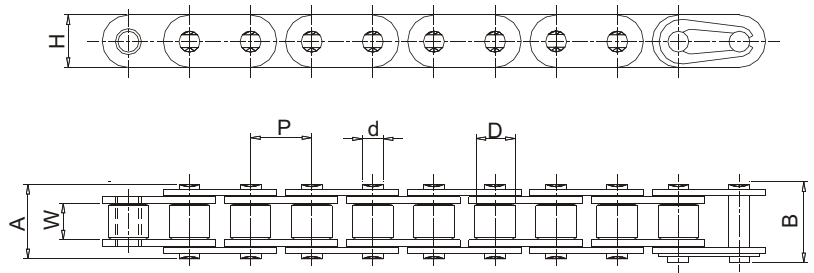

The straight side plate chains are identical to the corresponding European series standard chains except for the straight side plates. The chains have higher fatigue resistance than the standard chains.

SINGLE STRAND

Intl. Ref. No.	ROMBO Chain No.	Pitch (P)	Width between Inner Plates (W) (Min)	Roller Dia (D) (Max)	Bearing Pin Dia (d) (Max)	Plate Height (H) (Max)	Width Over Bearing Pin (A) (Max)	Width Over Joint Fasteners (B) (Max)	Projected Bearing Area (Sq.cm)	Avg. Weight Per Metre (Kg)	Tensile Strength (KN) (Min)	Tensile Strength (KN) (Avg.)	Spares Availability
C08B	D083 01 ST 01	12.70	7.75	8.51	4.45	11.80	17.00	20.90	0.50	0.75	18.00	21.10	A,B,C,D
C10B	D101 01 ST 01	15.875	9.65	10.16	5.08	14.70	19.60	23.70	0.67	0.98	22.40	27.45	A,B,C,D
C12B	D120 01 ST 01	19.05	11.68	12.07	5.72	16.10	22.70	27.30	0.88	1.24	29.00	32.35	A,B,C,D
C16B	D160 01ST 01	25.40	17.02	15.88	8.27	24.10	36.10	41.50	2.07	3.30	60.00	70.60	A,B,C,D
	D160 01 ST 02	25.40	17.02	15.88	8.27	20.58	36.10	41.50	2.07	3.30	60.02	70.60	A,B,C,D
C20B	D200 01 ST 01	31.75	19.56	19.05	10.19	26.40	43.20	49.30	2.91	3.91	95.00	109.85	A,B,C,D
C24B	D240 01 ST 01	38.10	25.40	25.40	14.63	33.40	53.40	60.00	5.49	7.16	160.00	179.00	B,C,D
C28B	D280 01 ST 01	44.45	30.99	27.94	15.90	37.00	65.10	72.50	7.26	8.79	200.00	226.00	B,C,D
C32B	D320 01 ST 01	50.80	30.99	29.21	17.81	42.20	67.40	75.30	8.05	10.42	250.07	272.80	B,C,D

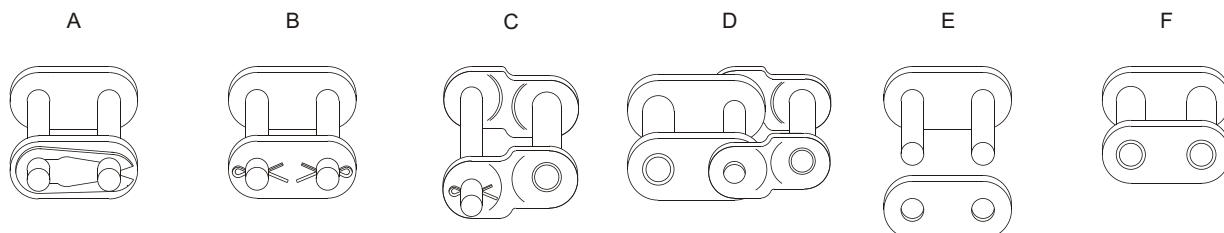

Spares E & F are available for all models

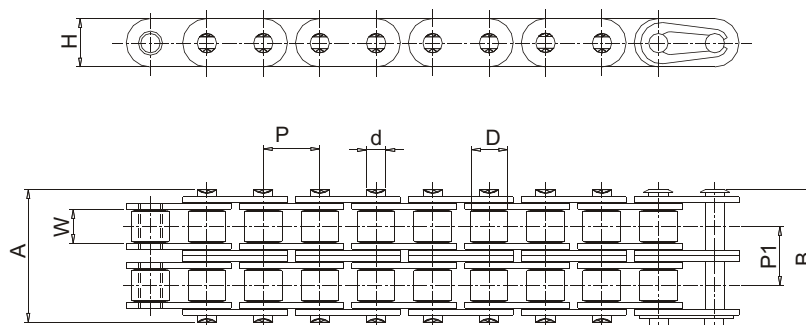

DOUBLE STRAND

Intl. Ref. No.	ROMBO Chain No.	Pitch (P)	Width between Inner Plates (W) (Min)	Roller Dia (D) (Max)	Bearing Pin Dia (d) (Max)	Plate Height (H) (Max)	Width Over Bearing Pin (A) (Max)	Width Over Joint Fasteners (B) (Max)	Transverse Pitch (P1)	Projected Bearing Area (Sq.cm)	Avg. Weight Per Metre (Kg)	Tensile Strength (KN) (Min)	Tensile Strength (KN) (Avg.)	Spares Availability
C08B	D083 02 ST 01	12.70	7.75	8.51	4.45	11.80	31.00	34.90	13.92	1.00	1.44	32.00	38.05	A,B,C,D
C10B	D101 02 ST 01	15.875	9.65	10.16	5.08	14.70	36.20	40.30	16.59	1.34	1.97	44.50	57.30	A,B,C,D
C12B	D120 02 ST 01	19.05	11.68	12.07	5.72	16.10	42.20	46.80	19.46	1.76	2.27	57.80	65.70	A,B,C,D
C16B	D160 02 ST 01	25.40	17.02	15.88	8.27	24.10	68.00	73.40	31.88	4.14	5.81	113.76	137.55	A,B,C,D
	D160 02 ST 02	25.40	17.02	15.88	8.27	20.58	68.00	73.40	31.88	4.14	5.78	113.76	137.55	A,B,C,D
C20B	D200 02 ST 01	31.75	19.56	19.05	10.19	26.40	79.00	85.10	36.45	5.82	7.72	170.00	210.00	B,C,D
C24B	D240 02 ST 01	38.10	25.40	25.40	14.63	33.40	101.00	107.60	48.36	10.98	14.15	280.00	322.50	B,C,D
C28B	D280 02 ST 01	44.45	30.99	27.94	15.90	37.00	124.00	131.40	59.56	14.52	17.39	360.00	412.60	B,C,D
C32B	D320 02 ST 01	50.80	30.99	29.21	17.81	42.20	126.00	133.90	58.55	16.10	20.63	450.00	510.80	B,C,D

TRIPLE STRAND

Intl. Ref. No.	ROMBO Chain No.	Pitch (P)	Width between Inner Plates (W) (Min)	Roller Dia (D) (Max)	Bearing Pin Dia (d) (Max)	Plate Height (H) (Max)	Width Over Bearing Pin (A) (Max)	Width Over Joint Fasteners (B) (Max)	Transverse Pitch (P1)	Projected Bearing Area (Sq.cm)	Avg. Weight Per Metre (Kg)	Tensile Strength (KN) (Min)	Tensile Strength (KN) (Avg.)	Spares Availability
C08B	D083 03 ST 01	12.70	7.75	8.51	4.45	11.80	44.90	48.80	13.92	1.50	2.03	47.50	56.00	A,B,C,D
C10B	D101 03 ST 01	15.875	9.65	10.16	5.08	14.70	52.80	56.90	16.59	2.01	2.72	66.70	83.35	A,B,C,D
C12B	D120 03 ST 01	19.05	11.68	12.07	5.72	16.10	61.70	66.30	19.46	2.64	3.42	86.70	101.55	A,B,C,D
C16B	D160 03 ST 01	25.40	17.02	15.88	8.27	24.10	99.00	105.30	31.88	6.21	8.83	160.00	202.80	A,B,C,D
	D160 03 ST 02	25.40	17.02	15.88	8.27	20.58	99.90	105.30	31.88	6.21	8.86	170.64	202.80	A,B,C,D
C20B	D200 03 ST 01	31.75	19.56	19.05	10.19	26.40	116.00	122.10	36.45	8.73	11.53	250.00	306.55	A,B,C,D
C24B	D240 03 ST 01	38.10	25.40	25.40	14.63	33.40	150.00	156.60	48.36	16.47	21.15	425.00	490.60	B,C,D
C28B	D280 03 ST 01	44.45	30.99	27.94	15.90	37.00	184.00	191.40	59.56	21.78	26.00	530.00	625.95	B,C,D
C32B	D320 03 ST 01	50.80	30.99	29.21	17.81	42.20	281.00	291.00	58.55	24.15	30.84	670.00	775.00	B,C,D

Spares E & F are available for all models

STANDARD ROLLER CHAINS

STRAIGHT SIDE PLATE CHAINS - AMERICAN SERIES



ANSI B 29.4

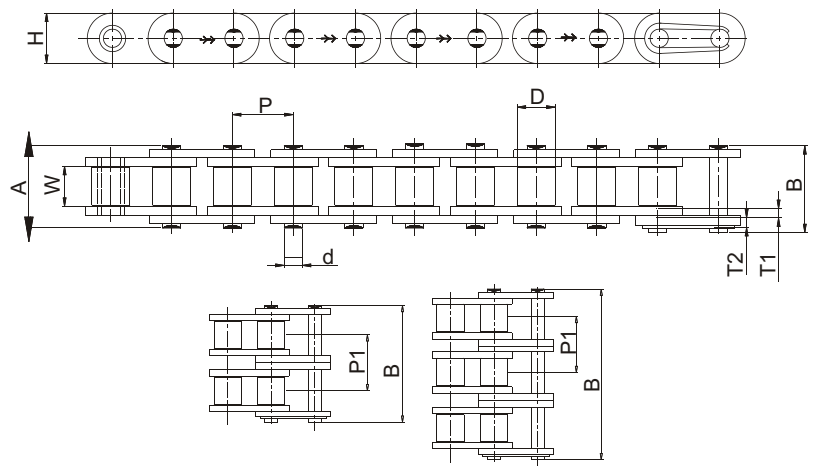

This straight side plate chains are identical to the corresponding American standard chains except for the straight side plates. The chains have higher fatigue resistance than the standard chains.

Intl. Ref. No.	ROMBO Chain No.	Pitch (P)	Width between Inner Plates (W) (Min)	Roller Dia (D) (Max)	Bearing Pin Dia (d) (Max)	Plate Height (H) (Max)	Plate Thickness Joint		Width Over Bearing Pin (A) (Max)	Width Over Joint Fasteners (B) (Max)	Transverse Pitch (P1)	Avg. Weight Per Metre (Kg)	Tensile Strength (KN) (Min)	Tensile Strength (KN) (Avg.)	Spares Availability
							IP	OP							
							T1	T2							
C40-1	D08A01ST01	12.70	7.85	7.92	3.96	12.00	1.50	1.50	17.80	21.70	14.38	0.67	14.1	18.87	A,B,C,D
C40-2	D08A02ST01								32.30	38.20		1.32	28.2	37.70	A,B,C,D
C40-3	D08A03ST01								46.70	50.80		1.98	42.3	56.60	A,B,C,D
C50-1	D10201ST02	15.875	9.40	10.16	5.08	15.00	2.00	2.00	21.80	25.90	18.11	1.59	22.2	30.40	A,B,C,D
C50-2	D10202ST02								39.90	44.00		2.06	44.4	60.80	A,B,C,D
C50-3	D10203ST02								57.90	62.00		3.07	66.6	82.50	A,B,C,D
C60-1	D12101ST01	19.05	12.58	11.91	5.94	18.00	2.39	2.39	26.90	31.50	22.78	1.76	31.8	41.70	A,B,C,D
C60-2	D12102ST01								49.70	54.40		3.12	63.6	83.40	A,B,C,D
C60-3	D12103ST01								72.60	77.20		4.67	95.4	120.10	A,B,C,D
C80-1	D16101ST01	25.40	15.75	15.88	7.92	24.10	3.15	3.15	33.50	38.90	29.29	3.23	56.7	72.60	A,B,C,D
C80-2	D16102ST01								62.70	68.10		5.2	113.4	145.15	A,B,C,D
C80-3	D16103ST01								91.90	97.10		7.77	170.1	201.95	A,B,C,D
C100-1	D20101ST01	31.75	18.90	19.05	9.53	30.10	4.00	4.00	41.10	47.20	35.76	4.01	88.5	110.40	A,B,C,D
C100-2	D20102ST01								77.70	83.10		7.93	177.0	220.85	A,B,C,D
C100-3	D20103ST01								113.00	119.10		11.86	265.5	313.90	A,B,C,D
C120-1	D24101ST01	38.10	25.22	22.23	11.10	36.20	4.70	4.70	50.80	57.40	45.44	5.74	127.0	144.65	B,C,D
C120-2	D24102ST01								96.30	102.90		11.37	254.0	289.30	B,C,D
C120-3	D24103ST01								141.03	147.60		17.01	381.0	433.95	B,C,D
C160-1	D32101ST01	50.80	31.55	28.58	14.27	47.78	6.30	6.30	65.50	73.40	58.55	7.47	226.8	253.40	B,C,D
C160-2	D32102ST01								124.00	131.90		14.81	453.6	506.75	B,C,D
C160-3	D32103ST01								182.00	189.90		22.16	680.4	760.15	B,C,D

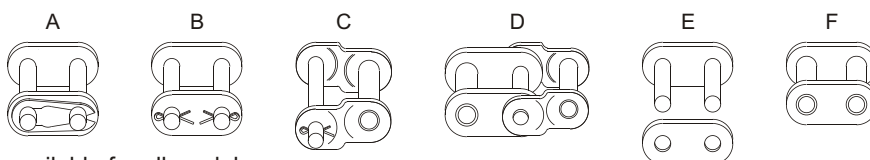

Spares E & F are available for all models

STANDARD ROLLER CHAINS

DOUBLE PITCH DRIVE CHAINS



ISO 1275/BS 4687/DIN 8181

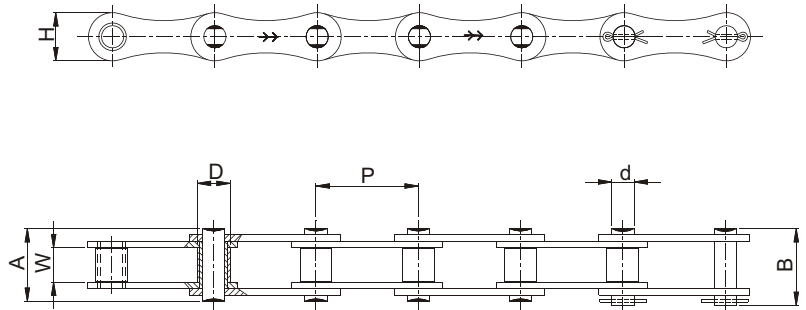

The pitch of the chains is twice that of standard chains while other components have the same dimensions of the corresponding standard chains. These cost effective chains are used in light load drives typically agriculture.

AMERICAN SERIES

Intl. Ref. No.	ROMBO Chain No.	Pitch (P)	Width between Inner Plates (W) (Min)	Roller Dia (D) (Max)	Pin Dia (d) (Max)	Plate Height (H) (Max)	Width Over Bearing Pin (A) (Max)	Width Over Joint Fasteners (B) (Max)	Avg. Weight Per Metre (Kg)	Tensile Strength (KN) (Min)	Tensile Strength (KN) (Avg.)
A2040	E08A01	25.40	7.85	7.92	3.96	11.65	17.80	21.70	0.41	13.90	18.87
A2050	E10201	31.75	9.40	10.16	5.08	13.90	21.80	25.90	0.66	21.77	30.40
A2060	E12101	38.10	12.58	11.91	5.94	18.10	26.90	31.50	1.03	31.19	41.70
A2080	E16101	50.80	15.75	15.88	7.92	24.10	33.50	38.90	1.70	55.60	72.60
A2100	E 20101	63.50	18.90	19.05	9.53	29.02	41.10	47.20	2.55	88.50	110.40
A2120	E 24101	76.20	25.22	22.23	11.10	34.82	50.80	57.40	4.06	127.00	144.65

EUROPEAN SERIES

208B	E08301	25.40	7.75	8.51	4.45	11.65	17.00	20.90	0.47	18.04	21.10
210B	E10101	31.75	9.65	10.16	5.08	13.90	19.60	23.70	0.68	22.40	27.45
212B	E12001	38.10	11.68	12.07	5.72	15.30	22.70	27.30	0.80	29.00	32.35
216B	E16001	50.80	17.02	15.88	8.27	20.65	36.10	41.50	1.42	60.00	70.60
220B	E20001	63.50	19.56	19.05	10.19	26.42	43.20	49.30	2.36	95.00	109.85
224B	E24001	76.20	25.40	25.40	14.63	33.40	53.40	60.00	4.70	160.00	179.00
228B	E28001	88.90	30.99	27.94	15.90	37.00	65.10	72.50	6.23	200.00	226.00
232B	E32001	101.60	30.99	29.21	17.81	42.20	67.40	75.30	6.72	250.00	272.80

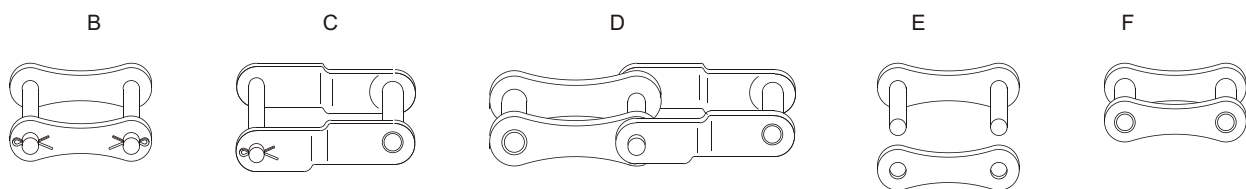

Above spares are available for all models

STANDARD ROLLER CHAINS

DOUBLE PITCH CONVEYOR CHAINS - AMERICAN SERIES



ISO 1275/ANSI B29.4

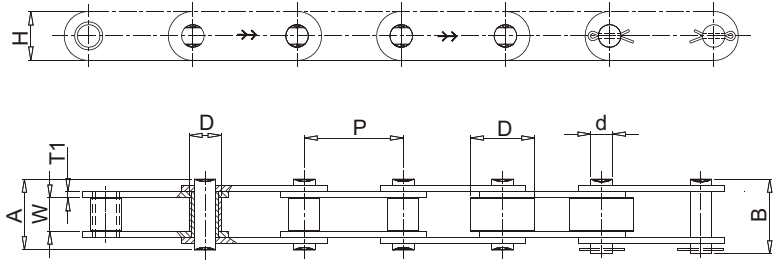

The chains are similar to double pitch power transmission chains, but the Link Plates have a straight contour and can be produced with standard or large rollers. They are used in conveyor applications where loads are low and speeds are moderate.

Intl. Ref. No.	ROMBO Chain No.	Pitch (P)	Width between Inner Plates (W) (Min)	Roller Dia*	Pin Dia (d) (Max)	Plate Height (H) (Max)	Plate Thickness (T1)	Width Over Bearing Pin (A) (Max)	Width Over Joint Fasteners (B) (Max)	Avg. Weight Per Metre (Kg)	Tensile Strength (KN) (Min)	Tensile Strength (KN) (Avg.)
				(D) (Max)		(H) (Max)						
C2040	A 08A 01	25.40	7.85	7.92	3.96	11.66	1.50	17.80	21.70	0.49	13.90	18.87
C2042	A 08A 02			15.88						0.84		
C2050	A 102 01	31.75	9.40	10.16	5.08	14.58	2.00	21.80	25.90	0.81	21.80	30.40
C2052	A 102 02			19.05						1.28		
C2060	A 121 01	38.10	12.58	11.91	5.94	18.06	2.39	26.90	31.50	1.20	31.27	41.70
C2062	A 121 02			22.23						1.92		
C2060H	A 122 01	38.10	12.58	11.91	5.94	18.06	3.15	31.20	35.80	1.50	31.27	42.15
C2062H	A 122 02			22.23						2.22		
C2080	A 161 01	50.80	15.75	15.88	7.92	24.05	3.15	33.50	38.90	2.10	55.60	72.60
C2082	A 161 02			28.58						3.18		
C2080H	A 162 01	50.80	15.75	15.88	7.92	24.05	4.00	38.00	43.40	2.52	55.60	72.60
C2082H	A 162 02			28.58						3.60		
C2100	A 201 01	63.50	18.90	19.05	9.53	29.26	4.00	41.10	47.20	3.21	86.87	110.40
C2102	A 201 02			39.67						5.45		
C2100H	A 202 01	63.50	18.90	19.05	9.53	29.26	4.70	43.40	46.70	3.56	86.87	110.40
C2102H	A 202 02			39.67						5.38		
C2120	A 241 01	76.20	25.22	22.23	11.10	36.20	4.70	50.80	57.40	4.66	125.10	144.65
C2122	A 241 02			44.45						7.66		
C2120H	A 242 01	76.20	25.22	22.23	11.10	36.20	5.56	55.10	61.70	5.26	125.10	144.65
C2122H	A 242 02			44.45						8.26		
C2160	A 321 01	101.60	31.55	28.58	14.27	48.26	5.56	65.50	73.40	8.15	222.40	253.40
C2162	A 321 02			57.15						13.00		
C2160H	A 322 01	101.60	31.55	28.58	14.27	48.26	7.14	70.00	77.90	9.06	222.40	253.40
C2162H	A 322 02			57.15						12.77		

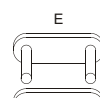
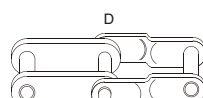
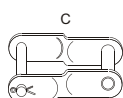
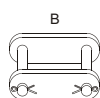

* Select roller diameter for ordering. Above spares are available for all models.

ATTACHMENTS - SPECIAL APPLICATIONS

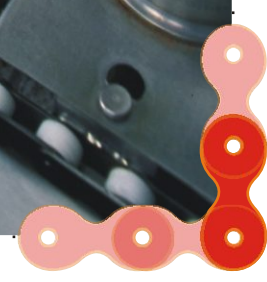

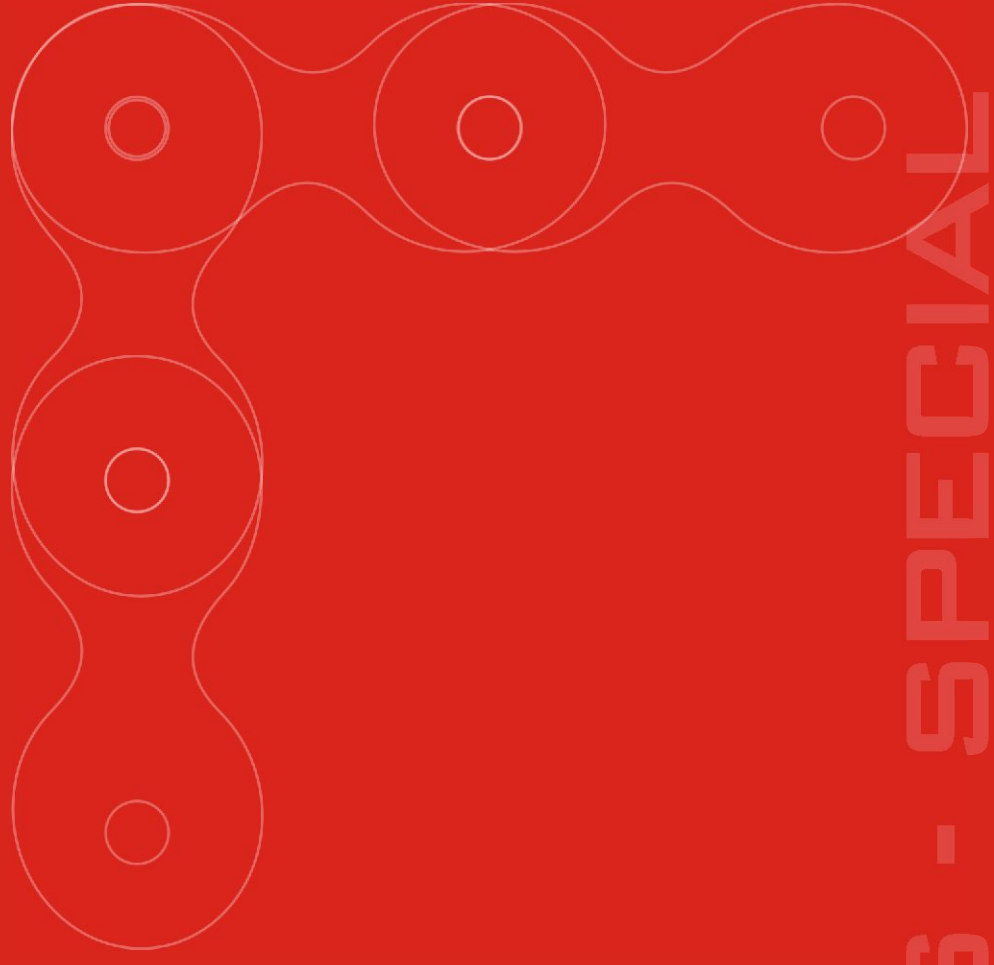

ATTACHMENTS - SPECIAL APPLICANTS

ATTACHMENT CHAINS

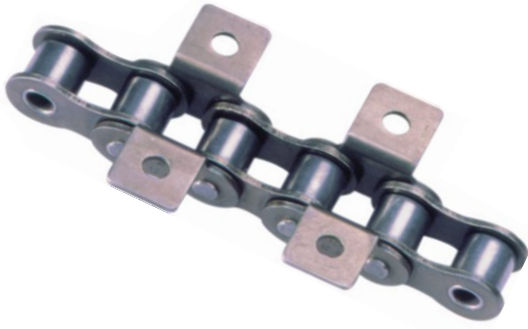

SHORT PITCH A1, K1 ATTACHMENTS

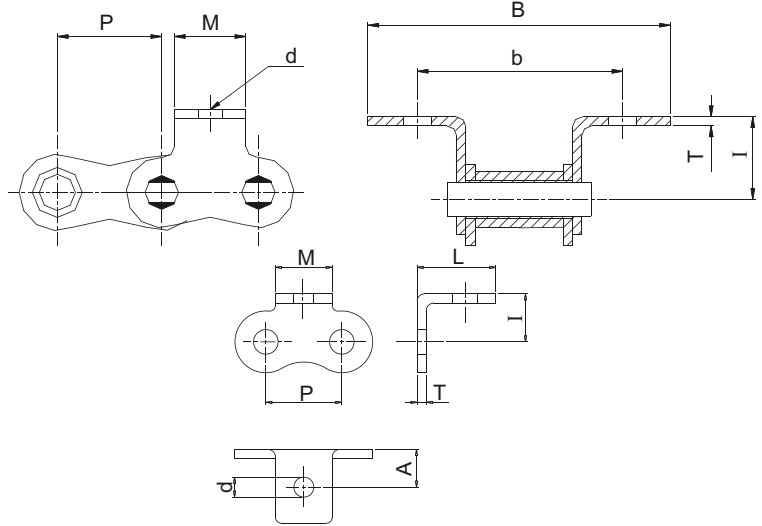

DIN 8187-2 Outer Attachments for European Series

BASE CHAIN MODEL	ROMBO ATT. No.	P	T	M	d	A	L	l	B	b
08B	46 D 083 01 K1 00	12.586	1.58	11.00	4.50	6.84	12.34	8.89	36.40	25.40
10B	46 D 101 01 K1 00	15.77	1.58	14.28	5.50	9.17	15.60	10.31	44.63	31.80
12B	46 D 120 01 K1 00	18.91	1.81	15.88	6.60	11.08	18.23	13.46	52.35	38.10
16B	32 D 160 01 K1 05	25.247	3.05	18.85	6.80	12.50	24.50	15.90	74.80	50.80
20B	32 D 200 01 K1 01	31.75	3.53	26.15	9.00	17.01	30.25	19.80	90.00	63.50

ANSI B29.1 Outer Attachments for American Series

BASE CHAIN MODEL	ROMBO ATT. No.	P	T	M	d	A	L	l	B	b
40	32 D 08A 01 K1 02	12.586	1.50	11.40	4.20	7.00	14.07	7.90	39.74	25.40
40	32 D 08A 01 K1 05	12.586	1.50	11.40	6.00	7.00	14.07	7.90	39.50	25.40
50	32 D 102 01 K1 06	15.77	2.00	14.27	5.10	8.82	17.50	10.31	49.10	31.75
60	32 D 121 01 K1 01	19.05	2.39	15.88	5.10	10.05	18.90	11.90	55.80	38.10
80	32 D 161 01 K1 01	25.247	3.05	18.85	7.00	13.70	27.20	12.70	73.80	50.80
100	32 D 201 01 K1 02	31.75	4.00	26.15	8.21	17.87	30.25	19.84	90.00	63.50
120	32 D 241 01 K1 03	38.10	4.70	33.45	9.81	20.08	34.38	23.01	104.80	76.20
140	32 D 281 01 K1 01	44.45	5.56	39.85	11.38	22.29	40.44	26.58	121.20	88.90
160	32 D 321 01 K1 02	50.80	6.30	45.85	13.11	24.83	47.53	31.75	141.00	101.60

Work Standard Outer Attachments for European Series

BASE CHAIN MODEL	ROMBO ATT. No.	P	T	M	d	A	L	l	B	b
06B	32 D 061 01 K1 02	9.45	1.00	8.00	3.50	5.04	9.04	6.50	27.00	19.00
08B	32 D 083 01 K1 05	12.586	1.58	9.50	4.30	8.24	12.74	8.40	37.20	28.20
10B	32 D 101 01 K1 02	15.77	1.58	14.10	5.20	9.18	17.10	10.40	47.60	31.80
12B	32 D 120 01 K1 04	18.91	1.81	15.85	5.60	9.51	17.50	12.00	51.60	35.00
16B	32 D 160 01 K1 01	25.247	3.05	45.90	6.80	13.71	25.11	14.80	76.00	53.20

Work Standard Inner Attachments for European Series

BASE CHAIN MODEL	ROMBO ATT. No.	P	T	M	d	A	L	l	B	b
06B	34 D 061 01 K1 00	9.525	1.25	8.00	3.50	6.51	10.51	6.50	27.00	19.00
08B	34 D 083 01 K1 09	12.70	1.58	9.50	4.30	10.06	14.56	8.40	37.20	28.20
10B	34 D 101 01 K1 03	15.862	1.58	14.10	5.20	10.94	17.10	10.40	44.12	31.80
12B	34 D 120 01 K1 05	19.05	1.81	16.00	5.60	11.54	17.50	12.00	47.21	35.00
16B	34 D 160 01 K1 07	25.40	3.60	19.00	6.80	16.32	25.50	15.90	69.17	50.80
20B	34 D 200 01 K1 02	31.75	4.40	25.25	8.40	21.70	32.95	19.85	83.80	63.50

A1 - Attachment on single side.

K1 - Attachment on both sides.

Note : Please select the required attachment either A1 or K1 and specify the frequency of attachment while ordering.

ATTACHMENT CHAINS

SHORT PITCH A2, K2 ATTACHMENTS

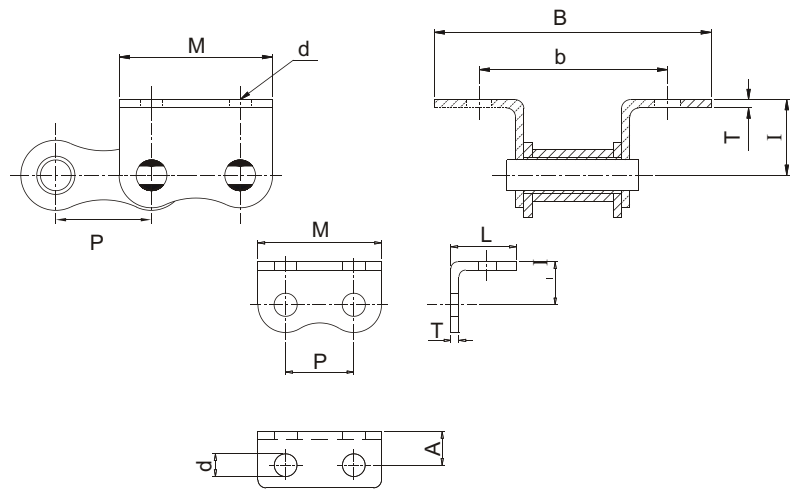

DIN 8187-2 Outer Attachments for European Series

BASE CHAIN MODEL	ROMBO ATT. No.	P	T	d	M	A	L	l	B	b
08B	48 D 083 01 K2 00	12.586	1.58	4.50	23.22	6.84	12.34	8.89	36.40	25.40
10B	48 D 101 01 K2 00	15.77	1.58	5.50	29.31	9.17	15.60	10.30	44.63	31.80
12B	48 D 120 01 K2 00	18.91	1.81	6.60	32.99	11.08	18.23	13.40	52.40	38.10
16B	32 D 160 01 K2 19	25.40	3.05	6.80	45.90	12.50	26.20	15.90	78.20	50.80
20B	48 D 200 01 K2 00	31.75	3.53	9.00	58.04	17.00	28.10	19.80	85.70	63.50

ANSI B29.1 Outer Attachments for American Series

BASE CHAIN MODEL	ROMBO ATT. No.	P	T	d	M	A	L	l	B	b
40	32 D 08A 01 K2 01	12.586	1.50	4.20	23.22	7.00	14.07	7.90	39.74	25.40
50	32 D 102 01 k2 01	15.77	2.00	5.50	29.28	8.85	16.35	10.30	46.80	31.81
60	32 D 121 01 K2 01	19.05	2.39	5.10	34.87	10.05	18.90	11.90	55.80	38.10
80	32 D 161 01 k2 03	25.247	3.05	6.80	45.90	13.91	27.20	15.90	77.40	50.80
100	32 D 201 01 K2 01	31.75	4.00	8.21	56.69	17.87	28.32	19.84	84.40	63.50
120	32 D 241 01 K2 01	38.10	4.70	9.81	68.71	20.08	34.38	23.01	104.80	76.20
140	32 D 281 01 K2 01	44.45	5.56	11.38	80.52	27.29	43.44	28.58	121.20	88.90
160	32 D 321 01 K2 01	50.80	6.30	13.11	91.44	27.83	47.53	31.75	141.00	101.60

Work Standard Outer Attachments for European Series

BASE CHAIN MODEL	ROMBO ATT. No.	P	T	d	M	A	L	I	B	b
06B	32 D 061 01 K2 01	9.525	1.00	3.50	17.60	5.04	9.04	6.50	27.00	19.00
08B	32 D 083 01 K2 03	12.586	1.58	4.30	23.22	8.24	12.74	8.40	37.20	28.20
10B	32 D 101 01 K2 01	15.77	1.58	5.30	29.31	9.18	17.10	10.40	47.60	31.80
12B	32 D 120 01 K2 04	18.91	1.81	5.60	32.99	9.52	22.54	12.00	61.00	35.00
16B	32 D 160 01 K2 01	25.40	3.05	8.00	45.90	13.71	25.11	14.80	76.00	53.20

A2 - Attachment on single side.

K2 - Attachment on both sides.

Note : Please select the required attachment either A2 or K2 and specify the frequency of attachment while ordering.

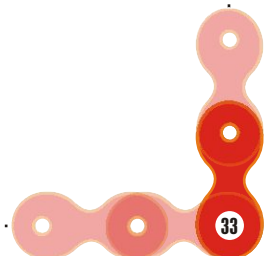

ATTACHMENT CHAINS



SHORT PITCH SM1, M1 ATTACHMENTS

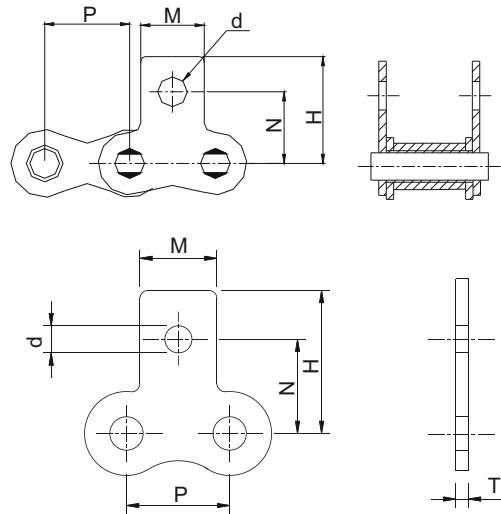

DIN 8187-2 Outer Attachments for European Series

BASE CHAIN MODEL	ROMBO ATT. No.	P	T	d	M	N	H
08B	42 D 083 01 M1 00	12.586	1.58	4.50	11.00	13.00	18.42
10B	42 D 101 01 M1 00	15.77	1.58	5.50	14.28	16.50	23.10
12B	42 D 120 01 M1 00	18.91	1.81	6.60	15.88	21.00	28.43
16B	42 D 160 01 M1 00	25.40	3.05	6.60	18.85	23.00	34.95
20B	42 D 200 01 M1 00	31.75	3.53	9.00	25.25	30.50	42.00

ANSI B29.1 Outer Attachments for American Series

BASE CHAIN MODEL	ROMBO ATT. No.	P	T	d	M	N	H
40	31 D 08A 01 M1 02	12.586	1.50	4.20	11.40	12.70	19.24
50	31 D 102 01 M1 03	15.77	2.00	5.10	14.28	15.88	24.20
60	31 D 121 01 M1 01	19.05	2.39	5.10	15.88	19.05	26.70
80	31 D 161 01 BM1	25.247	3.15	6.60	18.85	25.40	34.95
100	31 D 201 01 M1 01	31.75	4.00	8.21	22.25	31.75	42.00
120	31 D 241 01 M1 01	38.10	4.70	9.81	28.45	38.10	52.55
140	31 D 281 01 M1 01	44.45	5.50	11.38	34.85	44.50	64.32
160	31 D 321 01 M1 01	50.80	6.30	13.11	37.85	50.80	68.15

Work Standard Outer Attachments for European Series

BASE CHAIN MODEL	ROMBO ATT. No.	P	T	d	M	N	H
06B	31 D 061 01 M1 03	9.45	1.00	3.50	8.00	9.75	13.75
08B	31 D 083 01 M1 02	12.586	1.58	4.30	9.50	14.10	18.34
10B	31 D 101 01 M1 02	15.77	1.58	5.20	14.10	15.90	24.70
12B	31 D 120 01 M1 02	18.91	1.81	5.60	15.85	17.90	26.23
16B	31 D 160 01 M1 03	25.235	3.05	6.80	18.85	26.00	34.95
20B	31 D 200 01 M1 01	31.75	3.53	8.40	25.25	31.75	42.00

Work Standard Inner Attachments for European Series

BASE CHAIN MODEL	ROMBO ATT. No.	P	T	d	M	N	H
06B	34 D 061 01 M1 00	9.525	1.00	3.50	8.00	9.74	13.74
08B	33 D 083 01 M1 08	12.70	1.58	4.20	11.40	12.13	19.235
10B	33 D 101 01 M1 03	15.875	1.58	5.20	14.10	15.90	24.695
12B	33 D 120 01 M1 03	19.05	1.81	5.60	15.85	17.90	26.23
16B	33 D 160 01 M1 05	25.40	3.50	6.80	18.85	26.00	34.95
20B	33 D 200 01 M1 01	31.75	4.40	9.00	25.25	30.50	42.00

SM1 - Attachment on single side.

M1 - Attachment on both sides.

Note : Please select the required attachment either SM1 or M1 and specify the frequency of attachment while ordering.

ATTACHMENT CHAINS

SHORT PITCH SM2, M2 ATTACHMENTS

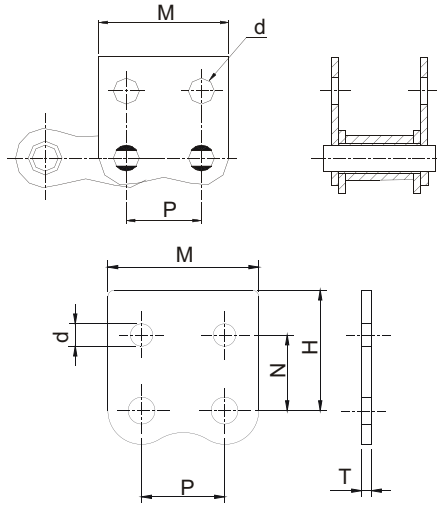

DIN 8187-2 Outer Attachments for European Series

BASE CHAIN MODEL	ROMBO ATT. No.	P	T	d	M	N	H
08B	44 D 083 01 M2 00	12.586	1.58	4.50	23.22	13.00	18.34
10B	44 D 101 01 M2 00	15.77	1.58	5.30	29.31	16.50	23.10
12B	44 D 120 01 M2 00	18.91	1.81	6.60	32.99	21.00	28.43
16B	44 D 160 01 M2 00	25.235	3.05	6.60	45.90	23.00	36.64
20B	44 D 200 01 M2 00	31.75	3.53	9.00	58.04	30.50	42.00

ANSI B29.1 Outer Attachments for American Series

40	31 D 08A 01 M2 02	12.586	1.50	4.20	23.22	12.70	19.24
50	31 D 102 01 M2 03	15.77	2.00	5.10	29.31	15.88	24.20
60	31 D 121 01 M2 01	19.05	2.39	5.10	34.87	19.05	26.70
80	31 D 161 01 BM2	25.247	3.15	6.60	45.90	25.40	36.64
100	31 D 201 01 M2 01	31.75	4.00	8.21	56.69	31.75	42.00
120	31 D 241 01 M2 01	38.10	4.70	9.81	68.71	36.53	52.55
140	31 D 281 01 M2 01	44.45	5.50	11.38	80.52	44.50	64.32
160	31 D 321 01 M2 01	50.80	6.30	13.11	91.44	50.80	68.15

Work Standard Outer Attachments for European Series

06B	31 D 061 01 M2 00	9.45	1.00	3.50	17.60	9.50	13.41
08B	31 D 083 01 M2 02	12.586	1.58	4.30	23.22	14.40	18.34
10B	31 D 101 01 M2 01	15.77	1.58	5.20	29.31	15.90	24.70
12B	31 D 120 01 M2 02	18.91	1.81	5.60	32.99	17.90	31.28
16B	31 D 160 01 M2 02	25.235	3.05	6.80	45.90	26.00	36.64

SM2 - Attachment on single side.

M2 - Attachment on both sides.

Note : Please select the required attachment either SM2 or M2 and specify the frequency of attachment while ordering.

ATTACHMENT CHAINS

DOUBLE PITCH A1,K1 ATTACHMENTS

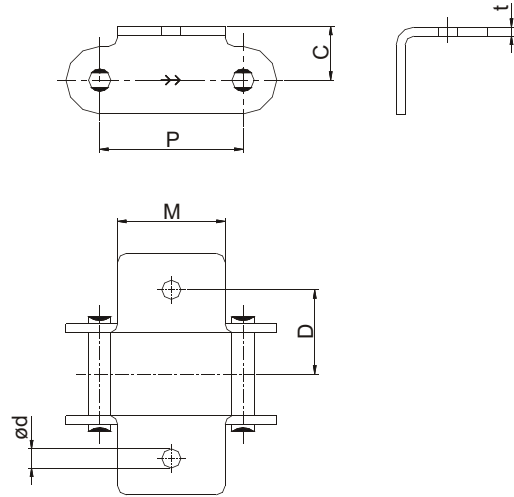

ANSI B 29.4 Outer attachments for American series

Base Chain Model	ROMBO Attachment No	Pitch (P)	Thickness (t)	M	d	D	C
C 2040	32-A 08A 01 BK1	25.40	1.50	19.10	3.33	12.70	9.12
C2042							
C2050	32-A 102 01 K1 01	31.75	2.00	23.80	5.08	15.83	11.13
C2052							
C2060	32-A 121 01 K1 01	38.10	2.39	28.60	5.08	21.44	14.68
C2062							
C2060H	32-A 122 01 K1 01	38.10	3.15	28.60	5.08	21.44	14.68
C2062H							
C2080	32-A 161 01 K1 01	50.80	3.15	38.10	6.63	27.79	19.05
C2082							
C2080H	32-A 162 01 BK1	50.80	4.00	38.10	6.63	27.79	19.05
C2082H							
C2100	32-A 201 01 K1 01	63.50	4.00	47.60	8.20	33.32	23.42
C2102							
C2100H	32-A 202 01 K1 01	63.50	4.70	47.60	8.20	33.32	23.42
C2102H							
C2120	32-A 241 01K1 01	76.20	4.70	57.20	9.80	39.67	27.79
C2122							
C2120H	32-A 242 01 K1 01	76.20	5.56	57.20	9.80	39.67	27.79
C2122H							
C2160	32-A 321 01 K1 01	101.60	5.56	76.20	13.11	52.37	36.53
C2162							
C2160H	32-A 322 01 K1 01	101.60	7.14	76.20	13.11	52.37	36.53
C2162H							

A1 - Attachment on One side
K1- Attachment on Both sides

Note : Please select the required attachment either A1 or K1 and specify the frequency of attachments while ordering

ATTACHMENT CHAINS

DOUBLE PITCH A2, K2 ATTACHMENTS

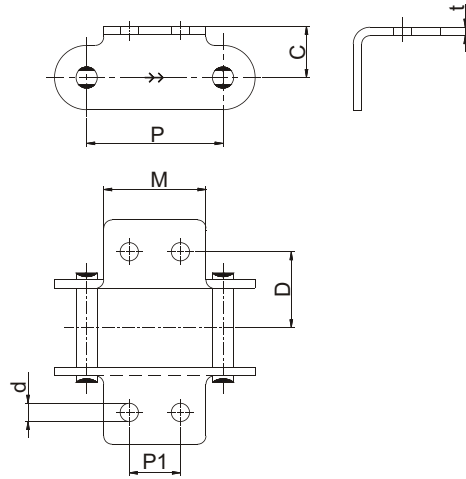
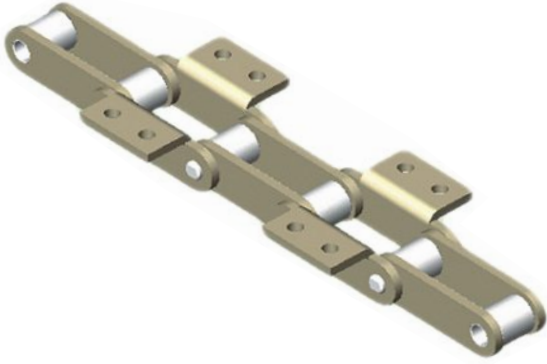

ANSI B 29.4 Outer attachments for American series

Base Chain Model	ROMBO Attachment No	Pitch (P)	Thickness (t)	M	d	D	C	P1
C 2040	32-A 08A 01 K2 01	25.40	1.50	19.10	3.33	12.70	9.12	9.52
C2042								
C2050	32-A 102 01 SK2	31.75	2.00	23.80	5.08	15.83	11.13	11.91
C2052								
C2060	32-A 121 01 SK2	38.10	2.39	28.60	5.08	21.44	14.68	14.30
C2062								
C2060H	32-A 122 01 K2 01	38.10	3.15	28.60	5.08	21.44	14.68	14.30
C2062H								
C2080	32-A 161 01 K2 01	50.80	3.15	38.10	6.63	27.79	19.05	19.05
C2082								
C2080H	32-A 162 01 K2 05	50.80	4.00	38.10	6.63	27.79	19.05	19.05
C2082H								
C2100	32-A 201 01 K2 01	63.50	4.00	47.60	8.20	33.32	23.42	23.83
C2102								
C2100H	32-A 202 01 K2 01	63.50	4.70	47.60	8.20	33.32	23.42	23.83
C2102H								
C2120	32-A 241 01 K2 01	76.20	4.70	57.20	9.80	39.67	27.79	28.58
C2122								
C2120H	32-A 242 01 K2 01	76.20	5.56	57.20	9.80	39.67	27.79	28.58
C2122H								
C2160	32-A 321 01 K2 01	101.60	5.56	76.20	13.11	52.37	36.53	38.10
C2162								
C2160H	32-A 322 01 K2 01	101.60	7.14	76.20	13.11	52.37	36.53	38.10
C2162H								

A2 - Attachment on One side
K2- Attachment on Both sides

Note : Please select the required attachment either A2 or K2 and specify the frequency of attachments while ordering

WORK STANDARD ATTACHMENT CHAINS

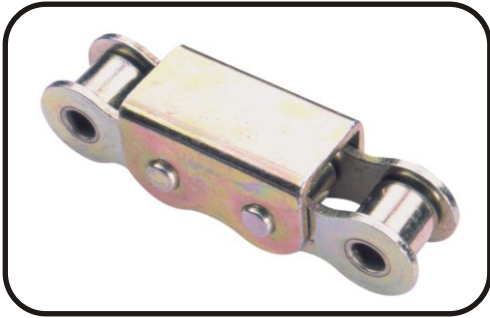

'U' ATTACHMENT

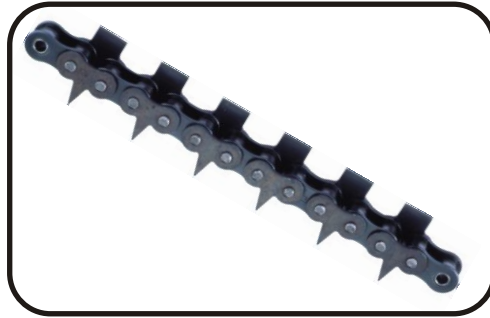

SPIKE ATTACHMENT



WELDED ATTACHMENT WITH TEFLON WASHER



WELDED ATTACHMENT



SPECIAL ATTACHMENT

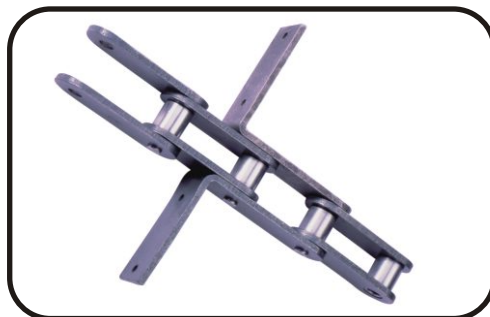

REDLER ATTACHMENT

EXTENDED PIN CHAINS

SHORT PITCH CHAINS

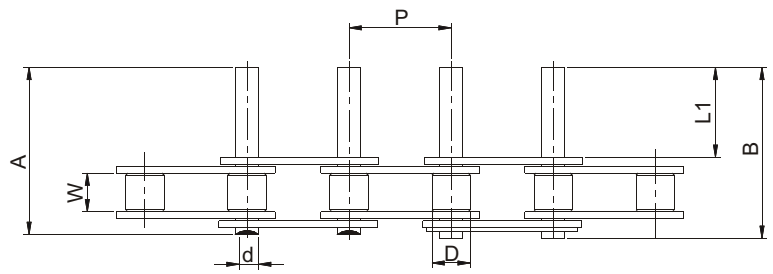

The series of Extended Pin Chains are used to transfer parts to different work stations, in indexing Mechanisms etc.

Intl Ref. No.	ROMBO Chain No.	Extended Pin Dia (d) (Max)	Pin Extension L1 (Nom)	Extended Pin Length A (Nom)	Extended Connecting Pin Length B (Nom)	Average Weight Per Metre (Kg)
05B-1	D05B01J101	2.31	3.00	10.95	11.85	0.18
05B-1	D05B01J104	2.31	5.00	12.25	13.15	0.19
06B-1*	D06101J101	3.27	4.32	16.05	17.65	0.42
06B-1*	D06101J103	3.27	11.00	22.75	24.35	0.47
08B-1	D08301J101	4.45	15.15	30.91	33.00	0.75
081C-1	D08001J101	3.63	12.00	20.95	22.16	0.37
10B-1	D10101J102	5.08	17.63	35.26	36.85	1.07
12B-1	D12001J113	5.72	20.83	41.66	43.07	1.22
16B-1	D16001J112	8.27	33.80	67.58	69.42	3.03
40-1	D08A01J101	3.97	24.60	40.00	41.00	0.75
60-1	D12101J104	5.94	24.10	48.25	49.65	1.77

* Straight side plate chains

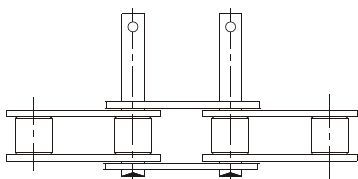

HOLE TYPE

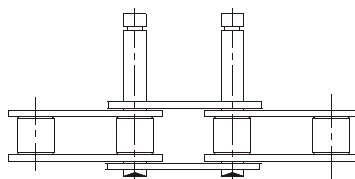

GROOVE TYPE

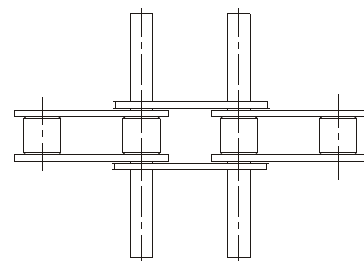

DOUBLE SIDE EXTENDED TYPE

Note : Extended Pin Length, Dia, Frequency as per customer requirement.
Pin Extension – one side, both sides available

EXTENDED PIN CHAINS

DOUBLE PITCH CHAINS

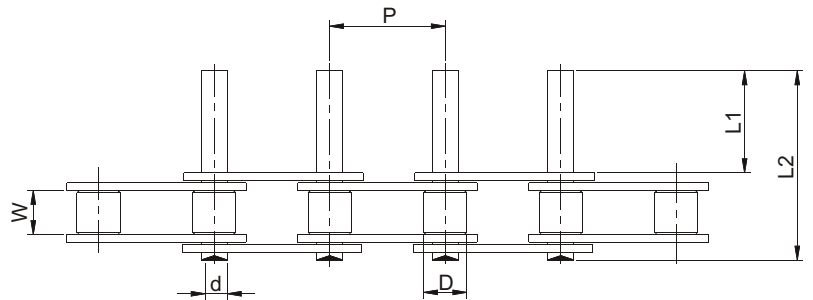
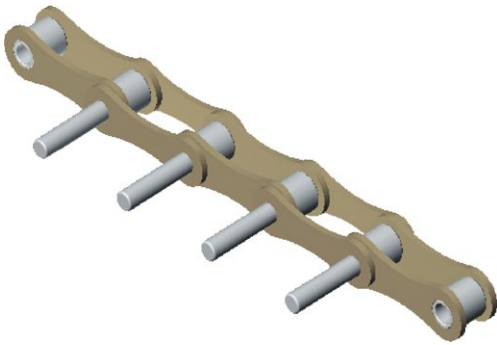

The Series of Extended Pin Chains are used to transfer parts to different work stations, in indexing Mechanisms etc.

AMERICAN SERIES

Intl Ref. No.	ROMBO Chain No. Base Chain	Pitch (P)	Width Between Inner Plates (W) (Min)	Roller Dia (D) (Max)	Extended Pin Dia (d) (Max)	Pin Extension L1	Extended Pin Length L2
A2040	E08A01	25.40	7.85	7.92	3.96	9.50	16.70
A2050	E10201	31.75	9.40	10.16	5.08	11.90	21.00
A2060	E12101	38.10	12.58	11.91	5.94	14.60	27.80
A2080	E16101	50.80	15.75	15.88	7.92	19.00	35.30
A2100	E20101	63.50	18.90	19.05	9.53	23.80	43.40
A2120	E24101	76.20	25.22	22.23	11.10	28.60	52.40

EUROPEAN SERIES

208B	E08301	25.40	7.75	8.51	4.45	9.50	16.70
210B	E10101	31.75	9.65	10.16	5.08	11.90	21.00
212B	E12001	38.10	11.68	12.07	5.72	14.60	27.80
216B	E16001	50.80	17.02	15.88	8.27	19.00	35.30
220B	E20001	63.50	19.65	19.05	10.19	28.80	43.40

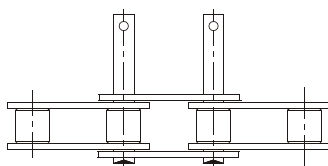

HOLE TYPE

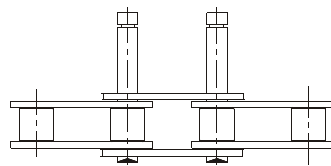

GROOVE TYPE

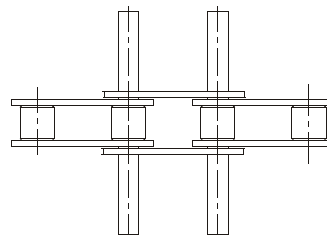

DOUBLE SIDE EXTENDED TYPE

Note : Extended Pin Length, Dia, Frequency as per customer requirement.
Pin Extension – one side, both sides available

DOUBLE PITCH

STRAIGHT SIDE PLATE - AMERICAN SERIES

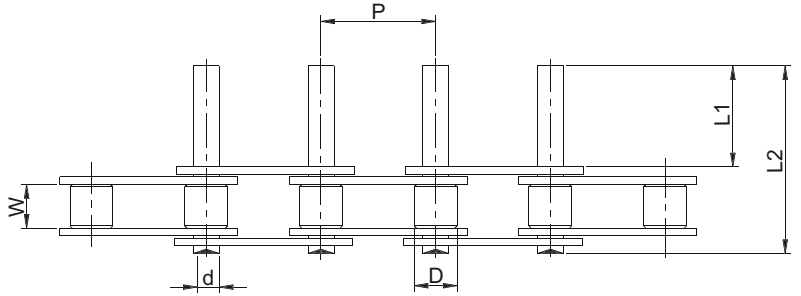
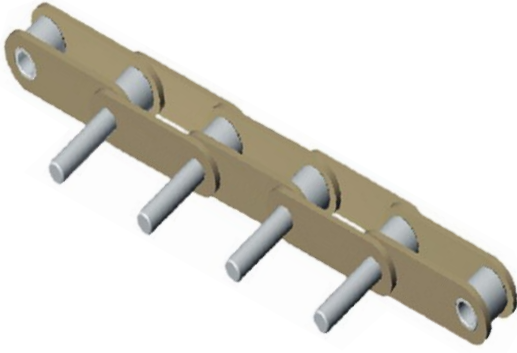

The series of Extended Pin Chains are used to transfer parts to different work stations, indexing Mechanisms etc.

AMERICAN SERIES

Intl Ref. No.	ROMBO Chain No. Base Chain	Pitch (P)	Width Between Inner Plates (W) (Max)	Roller Dia (D) (Max)	Extended Pin Dia (d) (Max)	*Pin Extension L1	Extended Pin Length L2
C 2040	A 08A 01	25.40	7.85	7.92	3.96	9.50	16.70
C2042	A 08A 02			15.88	3.96		
C2050	A 102 01	31.75	9.40	10.16	5.08	11.90	21.00
C2052	A 102 02			19.05	5.08		
C2060	A 121 01	38.10	12.57	11.91	5.94	14.60	27.80
C2062	A 121 02			22.23	5.94		
C2060H	A 122 01	38.10	12.57	11.91	5.94	14.60	27.80
C2062H	A 122 02			22.23	5.94		
C2080	A 161 01	50.80	15.75	15.88	7.92	19.00	35.30
C2082	A 161 02			28.58	7.92		
C2080H	A 162 01	50.80	15.75	15.88	7.92	19.00	35.30
C2082H	A 162 02			28.58	7.92		
C2100	A 201 01	63.50	18.90	19.05	9.53	23.80	43.40
C2102	A 201 02			39.67	9.53		
C2100H	A 202 01	63.50	18.90	19.05	9.53	23.80	43.40
C2102H	A 202 02			39.67	9.53		
C2120	A 241 01	76.20	25.23	22.23	11.10	28.60	52.40
C2122	A 241 02			44.45	11.10		
C2120H	A 242 01	76.20	25.23	22.23	11.10	28.60	52.40
C2122H	A 242 02			44.45	11.10		

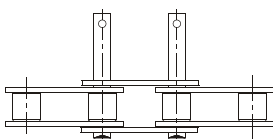

HOLE TYPE

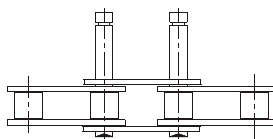

GROOVE TYPE

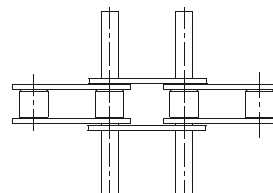

DOUBLE SIDE EXTENDED TYPE

Note : Extended Pin Length, Dia, Frequency and as per customer requirement. Pin Extension – one side, both sides available

WORK STANDARD EXTENDED PIN CHAINS

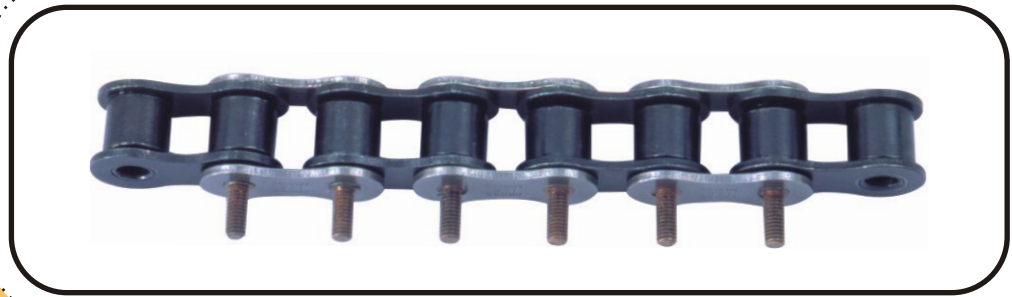

EXTENDED PIN CHAINS WITH THREADS

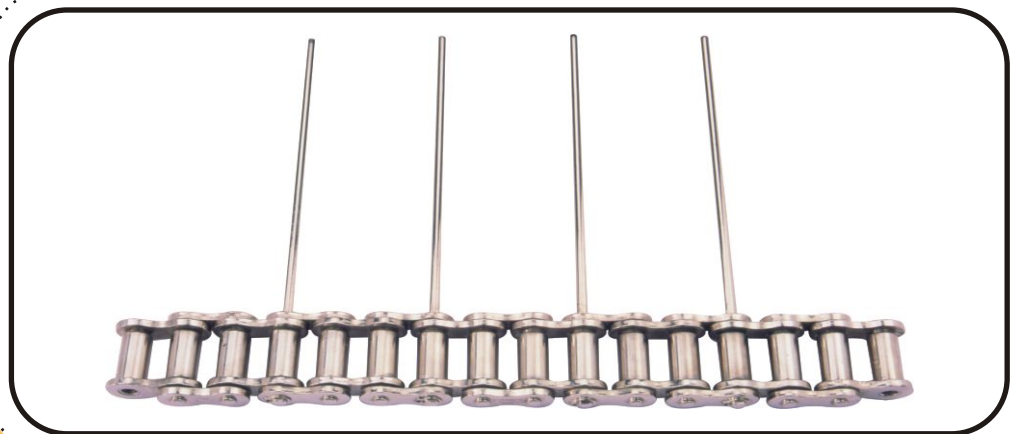

NICKEL PLATED EXTENDED PIN CHAINS

HOLLOW PIN CHAINS

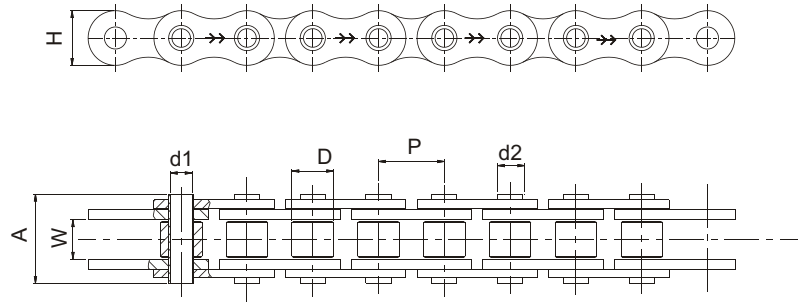

The series of hollow pin chains are used in conveyor applications allowing easy insertion of cross rods or attachments at desired frequency.

TYPE 1- WITH ROLLER, WITHOUT BUSH

ROMBO Chain No.	Pitch (P)	Width between Inner Plates (W) (Min)	Roller Dia (D) (Max)	Plate Height (H) (Max)	Pin Inner Diameter (d1) (Min)	Pin outer Diameter (d2)	Pin Length (A) (Max)	Avg. Weight Per Metre (Kg)	Tensile Strength (KN) Min	End Condition
D 061 01 HP 01 *	9.525	5.72	6.35	8.20	3.30	4.77	13.75	0.35	5.40	E
D083 01 HP 02	12.70	7.75	8.51	11.80	4.50	6.28	17.00	0.58	10.79	E
D 101 01 HP 02	15.875	9.65	10.16	14.70	5.18	7.02	19.60	0.77	14.71	E
D 102 01 HP 01	15.875	9.40	10.16	14.70	5.18	7.02	20.60	0.82	14.70	E
D 120 01 HP 01	19.05	11.68	12.07	16.10	5.85	8.09	22.70	0.98	16.68	E
D 160 01 HP 01	25.40	17.02	15.88	21.00	8.33	11.61	36.10	2.21	32.76	E

* Straight Sided Plates

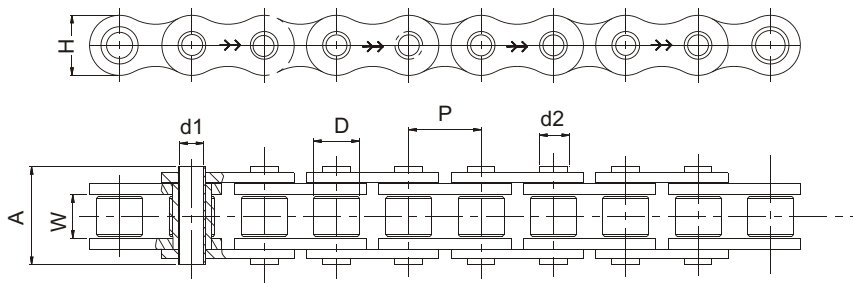

TYPE 2- WITH ROLLER AND BUSH

ROMBO Chain No.	Pitch (P)	Width between Inner Plates (W) (Min)	Roller Dia (D) (Max)	Plate Height (H) (Max)	Pin Inner Diameter (d1) (Min)	Pin outer Diameter (d2)	Pin Length (A) (Max)	Avg. Weight Per Metre (Kg)	Tensile Strength (KN) (Min)	End Condition
D 120 01 HP 02	19.05	11.68	12.07	16.10	5.00	8.09	22.70	1.13	22.60	E
D160 01 HP 02	25.40	17.02	15.88	21.00	5.00	8.26	33.90	2.34	36.20	E

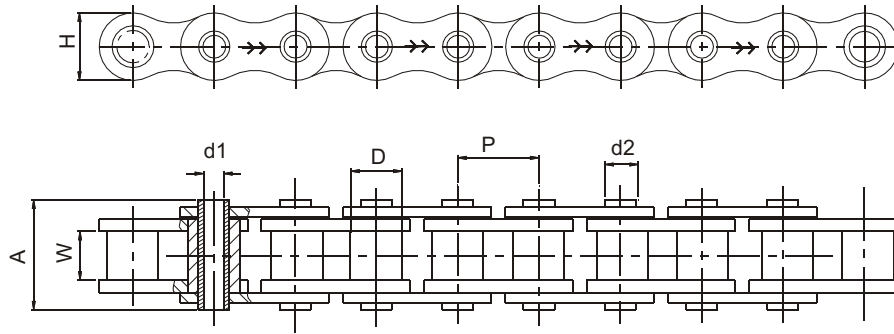

TYPE 3- WITH BUSH ,WITHOUT ROLLER

ROMBO Chain No.	Pitch (P)	Width between Inner Plates (W) (Min)	Roller Dia (D) (Max)	Plate Height (H) (Max)	Pin Inner Diameter (d1) (Min)	Pin outer Diameter (d2)	Pin Length (A) (Max)	Avg. Weight Per Metre (Kg)	Tensile Strength (KN) (Min)	End Condition
B 083 01 HP 01	12.70	7.75	8.51	11.80	4.50	6.28	17.20	0.58	9.32	E
B 101 01 HP 01	15.875	9.65	10.16	14.70	5.18	7.02	19.60	0.73	12.75	E
B 102 01 HP 01	15.875	9.53	10.16	14.70	5.18	7.02	20.50	0.85	18.14	E
B 120 01 HP 01	19.05	11.68	12.07	16.10	5.85	8.09	22.70	1.10	12.75	E

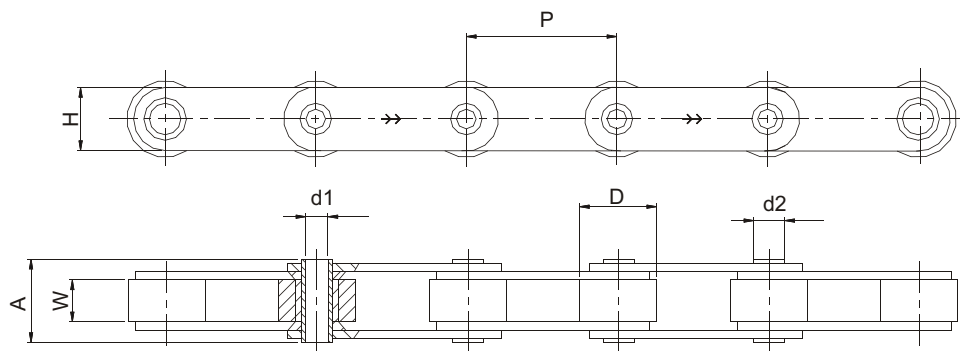

TYPE 4 - DOUBLE PITCH HOLLOW PIN CHAINS

ROMBO Chain No.	Pitch (P)	Width between Inner Plates (W) (Min)	Roller Dia (D) (Max)	Plate Height (H) (Max)	Pin Inner Diameter (D1) (Min)	Pin outer Diameter (d2)	Pin Length (A) (Max)	Avg. Weight Per Metre (Kg)	Tensile Strength (KN) (Min)	End Condition
A 102 01 HP 01	31.75	9.40	10.16	14.58	5.16	7.02	20.50	0.88	16.00	G
A 121 01 HP 01	38.10	12.57	11.91	18.06	5.99	8.38	25.50	1.08	22.70	G

Large Roller Chains

ROMBO Chain No.	Pitch (P)	Width between Inner Plates (W) (Min)	Roller Dia (D) (Max)	Plate Height (H) (Max)	Pin Inner Diameter (d1) (Min)	Pin outer Diameter (d2)	Pin Length (A) (Max)	Avg. Weight Per Metre (Kg)	Tensile Strength (KN) (Min)	End Condition
A 102 02 HP 01	31.75	9.40	19.05	15.09	5.16	7.02	20.5	1.26	16.00	G
A 121 02 HP 01	38.1	12.57	22.23	18.06	5.99	8.38	25.5	1.38	22.70	G
A 161 02 HP 01	50.8	15.75	28.58	24.05	8.02	11.38	32.5	3.17	41.14	G

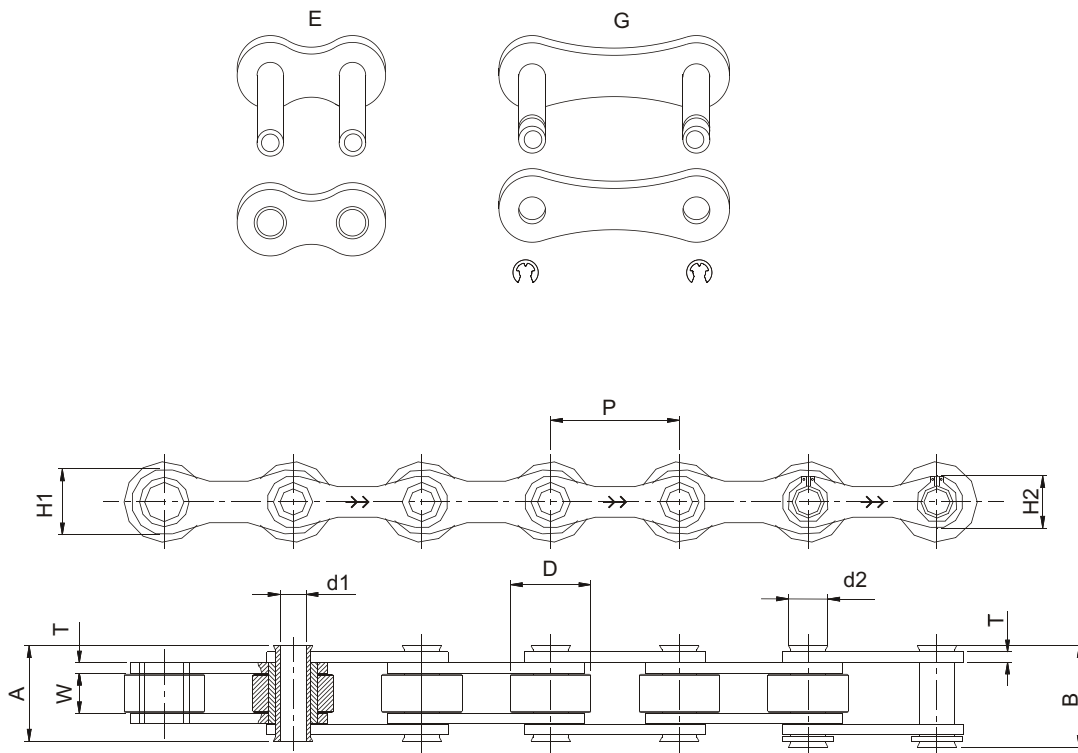

TYPE 5 - WITH CARRIER ROLLERS

ROMBO Chain No.	Pitch (P)	Width between Inner Plates (W) (Min)	Roller Dia (D) (Max)	Pin Inner Diameter (d1) (Min)	Pin outer Diameter (d2) (Min)	Plate Width IP (H1) (Max)	Plate Width OP (H2) (Max)	Plate Thickness (T)	Width Over Bearing Pin (A) (Max)	Width Over Joint Fasteners (B) (Max)	Average Weight Per Metre (Kg)	Tensile Strength (KN) (Min)
U 25401 HP 01	25.40	8.00	20.00	5.20	8.00	17.20	15.20	2.00	19.50	20.65	1.23	24.52
U 38101 HP 01	38.10	8.00	20.00	5.20	8.00	17.20	15.20	2.00	19.50	20.65	0.95	27.46
U 38101 HP 05 *	38.10	12.70	25.40	8.30	11.62	21.20	21.20	2.40	26.50	28.50	2.11	30.01
U50001 HP 02**	50.00	10.00	30.00	8.30	11.62	26.20	21.20	3.00	26.50	28.50	0.98	50.02
U50801 HP 01**	50.80	10.00	30.00	8.30	11.62	26.20	26.20	3.00	26.50	28.50	2.12	50.02
U50801 HP 02**	50.80	10.00	30.00	8.30	11.62	26.20	21.20	3.00	26.50	28.50	2.13	50.02
U 63001 HP 01	63.00	10.00	30.00	8.30	11.62	26.20	26.20	3.00	26.50	28.50	2.00	50.02
U 63005 HP 01 *	63.00	15.00	40.00	12.10	16.00	28.70	28.70	4.00	35.00	36.80	4.25	49.04

* Straight Contour Chains

** Stainless Steel Chains and Plastic Roller Chains are also available

ACCUMULATOR CHAINS

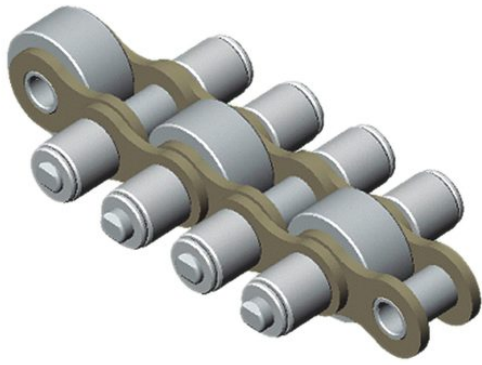

TYPE - 1

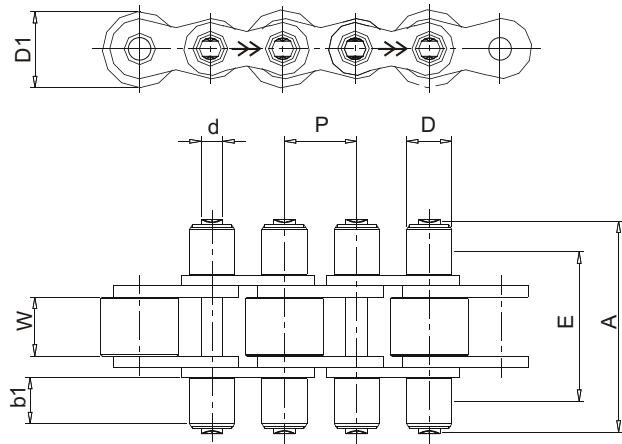

This type of conveyor chain are used for transporting parts, plates, pallets etc., which rests on the accumulator roller while the chain moves at a constant linear speed.

ROMBO Chain No.	Pitch (P)	Width Between inner plates (W) (Min)	Width of Outboard Roller (b1)	Roller Dia (D) (Max)	Pin Dia (d) (Max)	Pin length (A) (Max)	Centre Distance (E)	Conveyor Rollers			Avg. Weight Per Metre (Kg)	Tensile Strength (KN) (Min)
								Dia (D1)(Max)	Material			
									Steel	Plastic		
D083010B02	12.70	7.75	4.30	8.51	4.45	27.25	19.10	16.00	✓	✓	1.31	18.00
D120010B01	19.05	11.68	11.10	12.07	5.72	48.00	31.50	24.00	✓	✓	2.98	29.00
D120010B02	19.05	11.68	7.50	12.07	5.72	40.25	27.00	28.00	✓	✓	2.53	29.00
D120010B03	19.05	11.68	8.80	12.07	5.72	43.00	29.20	26.00	✓	✓	2.12	29.00
D160010B01	25.40	17.02	12.50	15.88	8.27	65.25	45.00	38.50	✓	✓	5.64	56.88

A

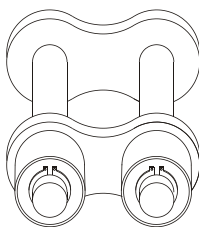

B

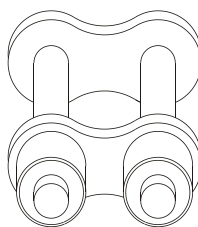

C

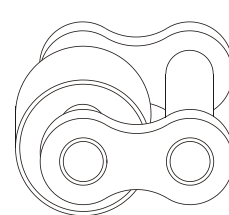

Spares available for all models

ACCUMULATOR CHAINS



TYPE - 2

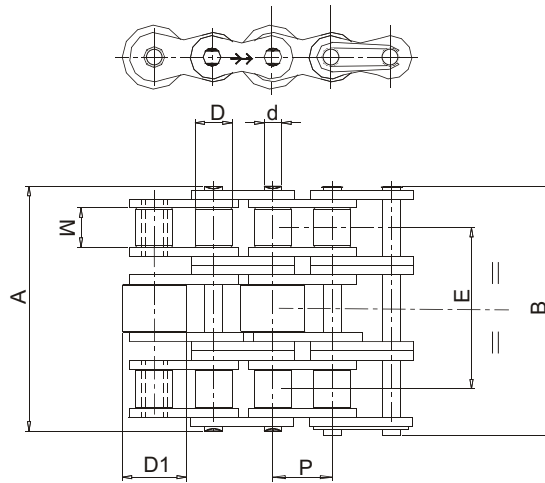

ROMBO Chain No.	Pitch (P)	Width Between inner plates (W) (Min)	Roller Dia (D) (Max)	Pin Dia (d) (Max)	Pin length (A) (Max)	Width Over Joint Fasteners (B) (Max)	Center Distance (E)	Conveyor Rollers		Avg. Weight Per Metre (Kg)	Tensile Strength (KN) (Min)	
								Dia (D1) (Max)	Material			
									Steel			Plastic
D083030003	12.70	7.75	8.51	4.45	44.90	46.75	27.84	16.00	✓	X	2.33	47.50
D120030001	19.05	11.68	12.07	5.72	61.70	63.00	38.92	22.00	✓	X	3.42	86.70
D120030002	19.05	11.68	12.07	5.72	61.72	63.00	38.92	28.00	✓	X	4.04	86.70
D160030001	25.40	17.02	15.88	8.28	99.90	101.50	63.76	38.50	✓	X	10.63	160.00
D160030002	25.40	17.02	15.88	8.28	99.90	101.50	63.76	27.00	✓	X	9.25	160.00

Note: Special requirements of 'E' and 'D1' can be made on request

ACCUMULATOR CHAINS



TOP ROLLER CHAINS

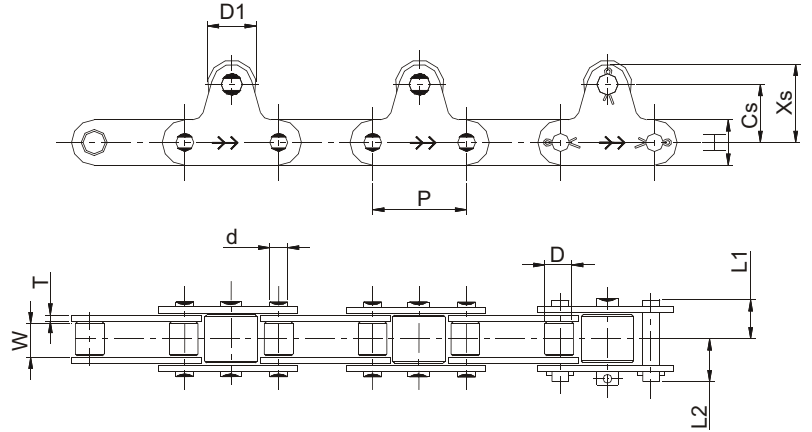

Intl. Ref. No.	Rombo Chain No.	Pitch (P)	Width between Inner plates (W) (Min)	Roller Dia		Pin (Max)			Link Plate		Cs	Xs	Material	
				D	D1	d	L1	L2	H	T			Steel	Plastic
C2040	A 08A01 TR01	25.40	7.85	7.92	15.88	3.97	8.25	9.95	11.66	1.50	15.00	21.00	✓	✓
C2050	A 10201 TR01	31.75	9.40	10.16	19.05	5.08	10.30	12.00	14.58	2.00	19.00	26.50	✓	✓
C2060	A 12101 TR01	38.10	12.58	11.91	22.23	5.94	14.55	16.55	18.06	3.15	23.00	31.60	✓	✓
C2080	A 16101 TR01	50.80	15.75	15.88	28.58	7.92	18.30	20.90	24.05	4.00	29.00	40.50	✓	✓
C2100	A 20101 TR01	63.50	18.90	19.05	39.67	9.53	21.80	24.50	29.26	4.70	35.40	49.70	✓	✓

Note : Chains with large rollers are also available on request

ACCUMULATOR CHAINS

SIDE ROLLER CHAINS

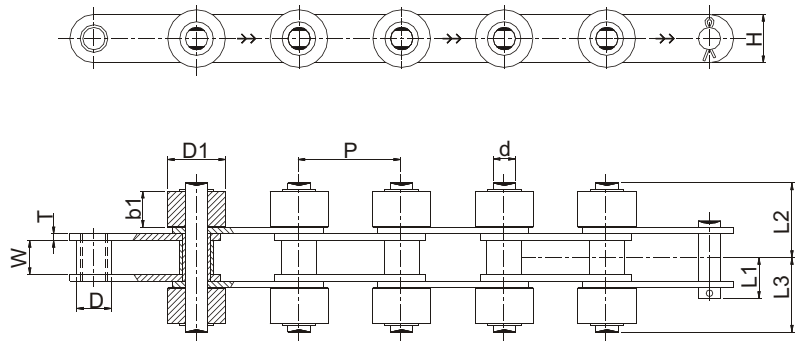
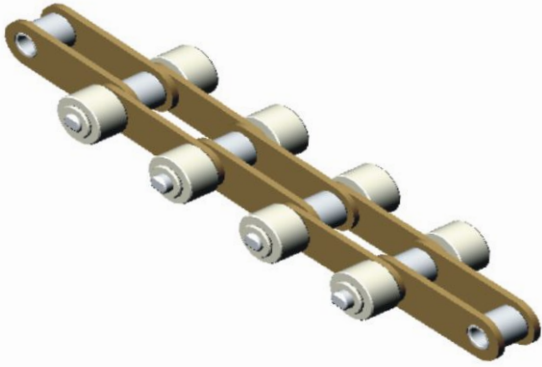

AMERICAN SERIES

Intl Ref No.	ROMBO Chain No.	Pitch (P)	Width between Inner plates (W) (Min)	Roller Dia (D) (Max)	Plate		Pin			Outboard Roller		Material		
					(T)	(H)	(d)	(L1)	(L2)	(L3)	(D1)	(B1)	Steel	Plastic
C2040	A 08A01 SR01	25.40	7.85	7.94	1.50	11.66	3.96	9.65	17.90	19.30	15.88	7.80	✓	✓
C2050	A 10201 SR01	31.75	9.40	10.16	2.00	14.58	5.08	11.90	21.60	23.20	19.05	9.40	✓	✓
C2060	A 12101 SR01	38.10	12.58	11.91	2.39	18.06	5.94	16.95	29.65	32.05	22.23	12.60	✓	✓
C2080	A 16101 SR01	50.80	15.75	15.88	4.00	24.05	7.92	20.95	36.65	39.65	28.58	15.80	✓	✓
C2100	A 20101 SR01	63.50	18.90	19.05	4.70	29.26	9.53	24.50	44.20	47.30	39.69	19.00	✓	✓

ACCUMULATOR CHAINS

DOUBLE PLUS CHAINS

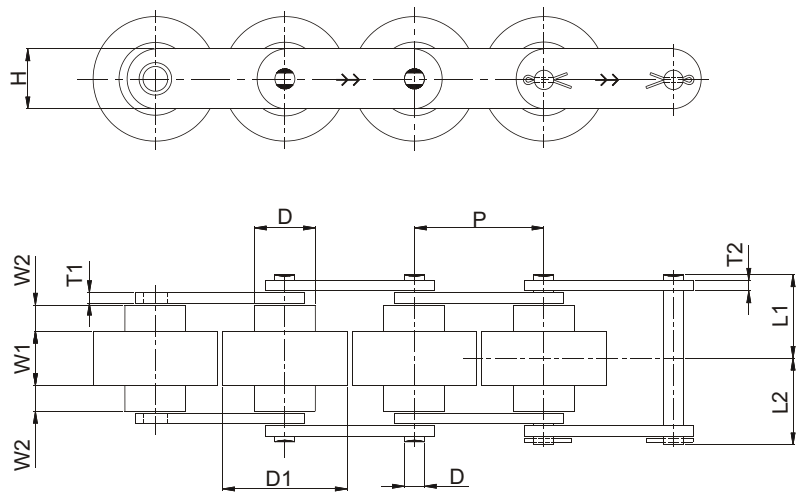

Intl Ref. No.	ROMBO Chain No.	Pitch (P)	(D)	(D1)	(W1)	(W2)	(T1)	(T2)	(H)	(D)	(L1)	(L2)	Avg. Weight Per Metre (Kg)
C2040	A08A01 DP 01	25.40	15.88	24.60	10.30	5.70	1.50	1.50	11.66	3.97	15.30	16.50	1.00
C2050	A10201 DP 01	31.75	19.05	30.60	13.00	7.10	2.00	2.00	14.58	5.09	19.15	19.85	1.40
C2060 H	A12Z 01 00 05	38.10	22.23	36.60	15.50	8.50	3.15	3.15	18.06	5.94	24.50	26.40	2.40

Note: Rollers are made of plastic material

RUBBER TOP CHAINS

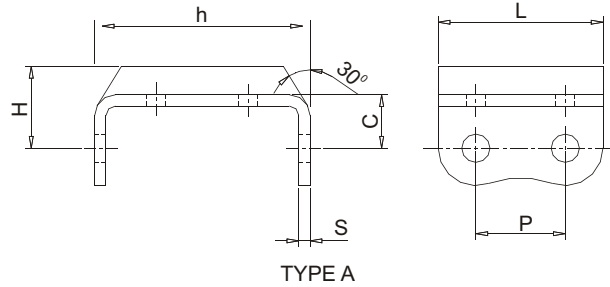
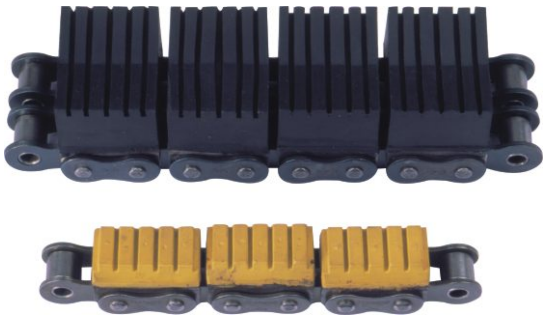

TYPE A

- * These chains are designed to face special needs in wood, tile, glass, carton printing, PVC tube extrusion industries.
- * The rubber attachment can be supplied with precision single or duplex roller chains
- * Special Profiles can be made on request

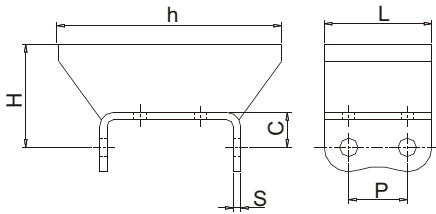

TYPE B

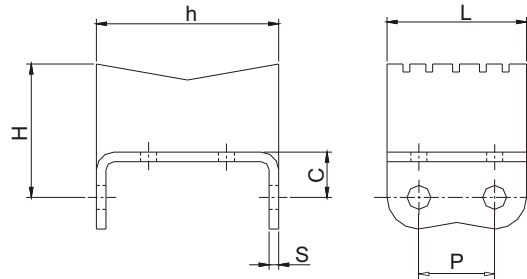

TYPE C

Grade	Natural Rubber	Nitrile Rubber	Neoprene Rubber
SHORE HARDNESS (A)	65+/-5	65+/-5	65+/-5
TEMPERATURE RANGE	- 10 to + 70 deg c	- 10 to + 120 deg c	- 10 to + 80 deg c
RESISTANCE TO OIL/GREASE	POOR	EXCELLENT	FAIR
OZONE / UV RESISTANCE	POOR	FAIR	EXCELLENT

Intl Ref. No.	ROMBO chain No.	Type	Pitch (P)	Width Over Bearing Pin (A)	C	H	h	L	S	Tensile Strength (KN) (Min)
08B-1	D08301RT01	A	12.70	17.80	8.30	12.30	14.72	24.00	1.50	18.04
80-1	D16101RT01	A	25.40	38.00	18.30	23.00	27.50	49.40	3.15	55.60
08B-2	D08302RT01	B	12.70	33.90	9.50	18.30	44.00	24.00	1.50	32.07
08B-2	D08302RT02	A	12.70	33.90	9.50	12.50	28.50	24.00	1.50	32.07
60-2	D12102RT01	C	19.05	53.00	11.80	33.80	45.56	34.87	2.00	62.37

SELF LUBE CHAINS

PLASTIC SLEEVE CHAINS

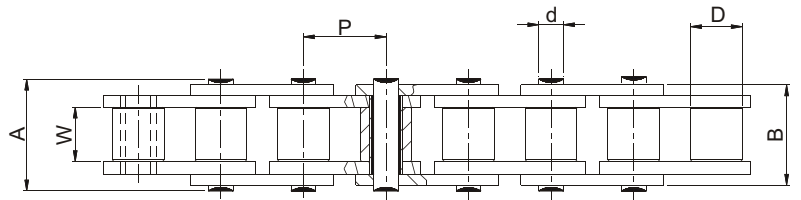
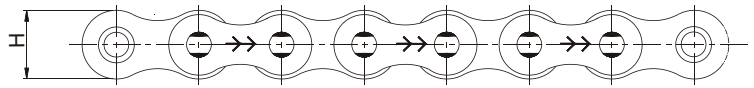
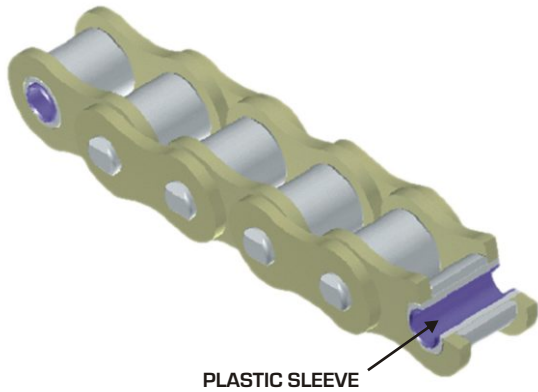

ROMBO Chain No.	Pitch (P)	Width between Inner Plates (W) (Min)	Roller Dia (D) (Max)	Plate Width (H) (Max)	Bearing Pin Dia (D) (Max)	Width Over Bearing Pin (A) (Max)	Width Over Joint Fasteners (B) (Max)	Transverse Pitch (P1)	Projected Bearing Area Sq.cm	Avg. Weight Per Metre (Kg)	Tensile Strength KN (Min)
E08301ZPB01*	25.40	7.75	8.51	11.80	4.45	17.00	20.90	-	0.50	0.47	13.73
D12Y01PB01	19.05	12.57	11.91	18.00	5.94	26.90	31.50	-	1.04	1.52	31.19
D12Y02PB01	19.05	12.57	11.91	18.00	5.94	49.70	54.40	22.78	2.08	3.01	62.37

* Double Pitch Zinc Plated Chains

SINTERED BUSH CHAINS

These chains are designed for clean environment applications where greasing is often not possible: like food processing, printing and pharmaceuticals. The bush has a unique powder alloy steel composition, that allows it to be impregnated with a special oil. Offers a wear-life up to two times in excess of standard chains.

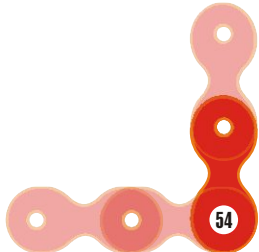
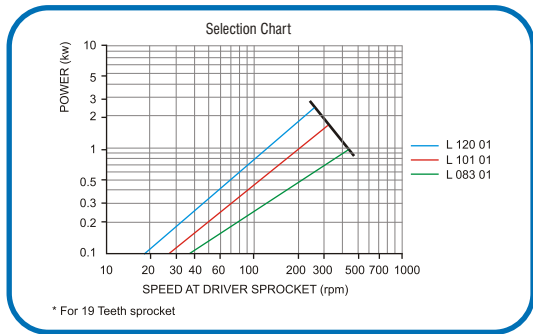
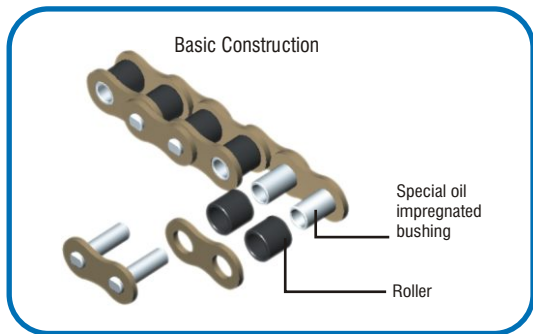

SELF LUBE CHAINS

ROMBO MAX SINTERED BUSH CHAINS

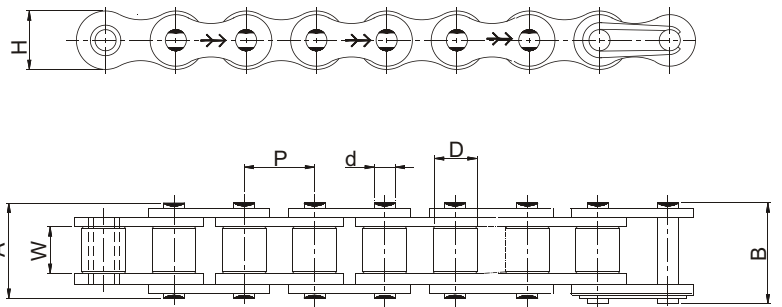

ROMBO MAX sintered bush chains are recommended for applications where lubrication is often not possible like food processing, printing, pharmaceuticals and electronics.

Intl Ref. No.	ROMBO Chain No.	Pitch (P)	Width between Inner Plates (W) (Min)	Roller Dia (D) (Max)	Plate Height (H) (Max)	Width Over Bearing Pin (A) (Max)	Bearing Pin Dia (d) (Max)	Width Over Joint Fasteners (B) (Max)	Projected Bearing Area Sq.cm	Avg. Weight Per Metre (Kg)	Tensile Strength (KN) (Min)	Tensile Strength (KN) (Avg.)	Spares Availability
08B-1	L083 01	12.70	7.75	8.51	12.40	17.00	4.45	20.90	0.50	0.70	18.0	19.6	A,B,C,D
10B-1	L101 01	15.875	9.65	10.16	14.70	19.60	5.08	23.70	0.69	0.88	22.4	25.7	A,B,C,D
12B-1	L120 01	19.05	11.68	12.07	16.10	22.70	5.72	27.30	0.92	1.10	29.0	30.4	A,B,C,D

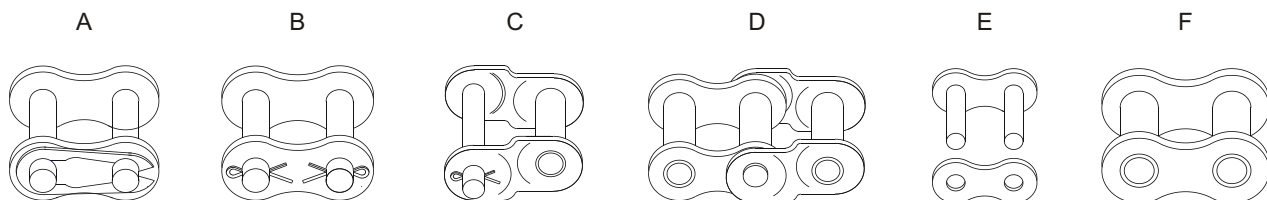

E & F are available for all models

"O" RING CHAINS

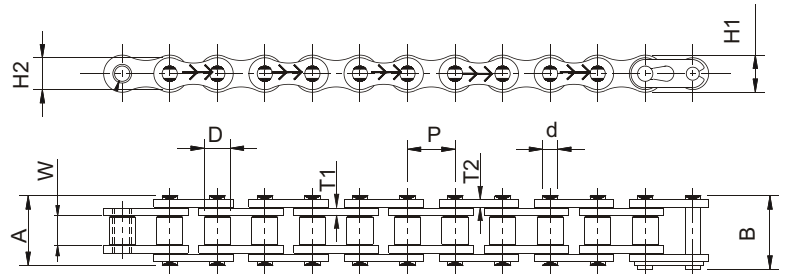

Rombo 'O' ring chains with unique design are engineered to offer superior resistance to wear.

AUTOMOTIVE 'O' RING CHAINS

Intl. Ref. No.	ROMBO Chain No. Base Chain	Pitch (P)	Width between Inner Plates (W) (Min)	Roller Diameter (D) (Max)	IP Height (H1) (Max)	OP Height (H2) (Max)	IP Thickness (T1) (Max)	OP Thickness (T2) (Max)	Width Over Bearing Pin (A) (Max)	Bearing Pin Diameter (d) (Max)	Width Over Joint Fasteners (B) (Max)	Average Weight Per Metre (Kg)	Tensile Strength KN (Min)
J415 OR	D 087 01	12.70	5.15	7.75	10.57	10.57	1.37	1.37	15.10	4.07	16.24	0.476	13.73
J428 OR	D 089 01	12.70	7.95	8.51	11.56	10.57	1.58	1.50	19.00	4.50	20.30	0.693	18.14
J520 OR	D 105 01	15.875	6.35	10.16	14.48	13.51	2.00	2.00	20.57	5.07	22.04	0.944	24.52

OTHER 'O' RING CHAINS

Intl. Ref. No.	ROMBO Chain No. Base Chain	Pitch (P)	Width between Inner Plates (W) (Min)	Roller Diameter (D) (Max)	IP Height (H1) (Max)	OP Height (H2) (Max)	IP Thickness (T1) (Max)	OP Thickness (T2) (Max)	Width Over Bearing Pin (A) (Max)	Bearing Pin Diameter (d) (Max)	Width Over Joint Fasteners (B) (Max)	Average Weight Per Metre (Kg)	Tensile Strength KN (Min)
08B OR	D 083 01	12.70	7.75	8.51	11.56	10.57	1.58	1.50	19.00	4.45	20.30	0.693	17.85
10B OR	D 101 01	15.875	9.65	10.16	14.48	13.51	1.58	1.58	21.94	5.06	23.53	0.921	22.21

WORK STANDARD SPECIAL CHAINS

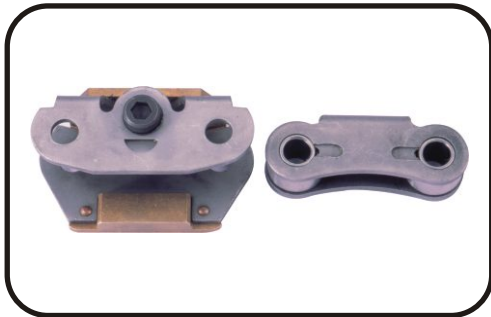

TEXTILE INDUSTRY



HOLLOW PIN CHAIN SPECIAL CONTOUR

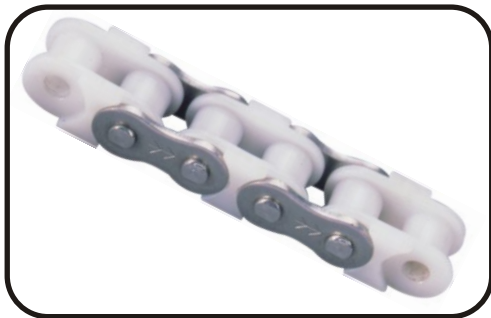

FOOD PROCESSING INDUSTRY



LIGHTING INDUSTRY

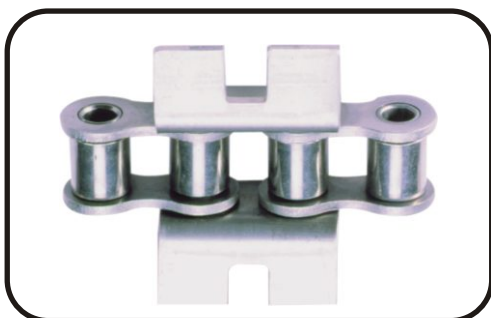

STAINLESS STEEL ATTACHMENT

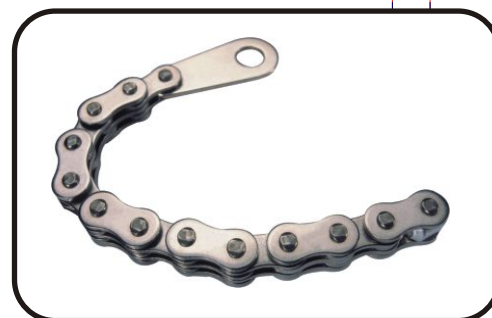

STAINLESS STEEL LEAF CHAIN

CORROSION RESISTANT CHAINS

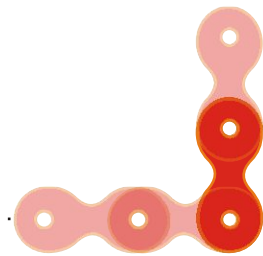

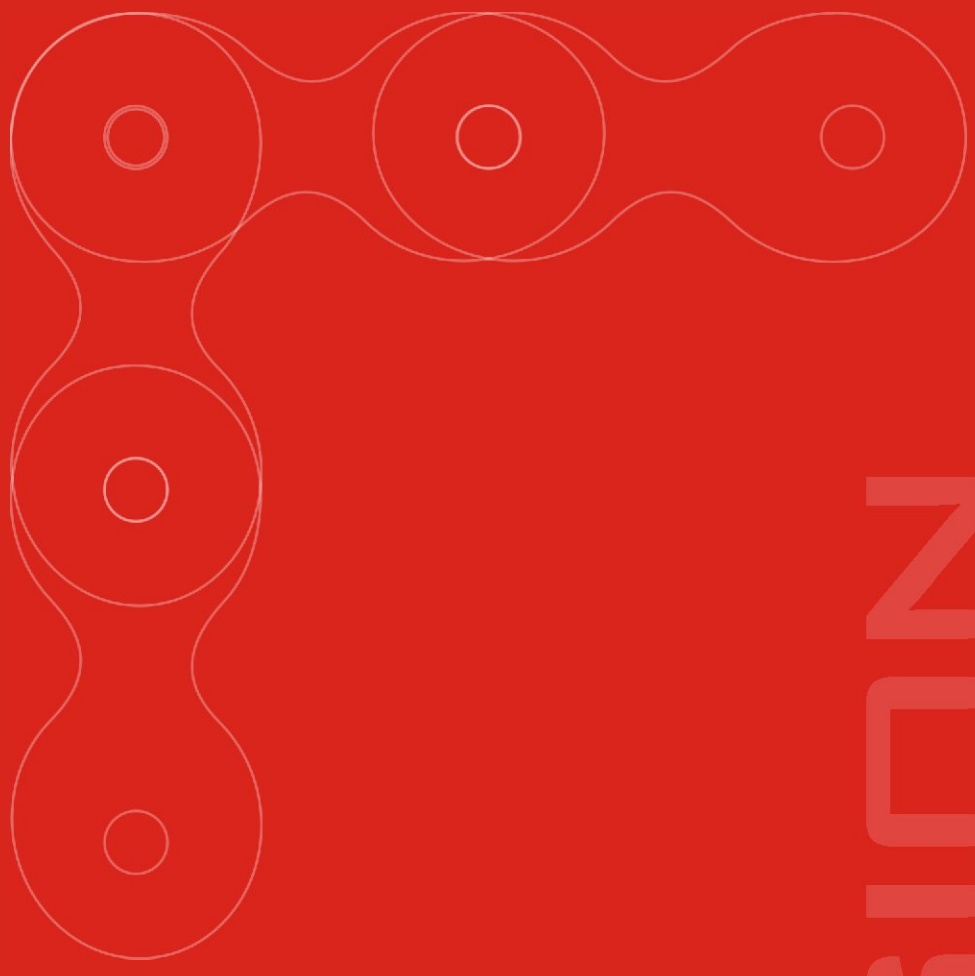

CORROSION

RESISTANT CHAINS

CORROSION RESISTANT CHAINS

STAINLESS STEEL CHAINS - EUROPEAN SERIES

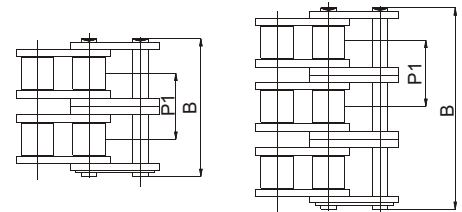
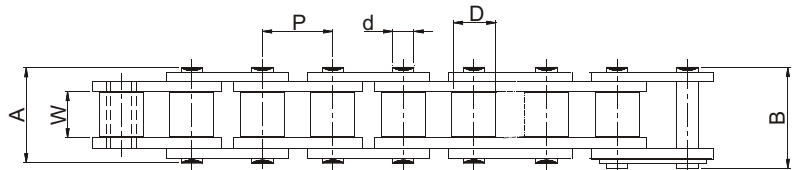
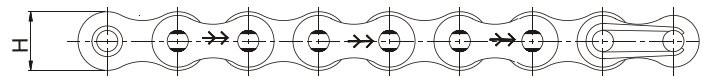

Stainless steel (SS 304) chains with solid rollers are designed to offer excellent corrosion resistance and are used in atmosphere where chains are exposed to chemical, water and heat. They can operate in a temperature range of -20 deg c to 400 deg c

SINGLE STRAND

Intl Ref. No.	Rombo Chain No.	Pitch (P)	Width between Inner Plates (W) (Min)	Roller Dia (D) (Max)	Plate Height (H) (Max)	Bearing Pin Dia (d) (Max)	Width Over Bearing Pin (A) (Max)	Width Over Joint Fasteners (B) (Max)	Transverse Pitch (P1)	Projected Bearing Area (Sq.cm)	Avg. Weight Per Metre (Kg)	Tensile Strength (KN) (Min)
05B-1	D05B01SS01	8.00	3.00	5.00	7.10	2.31	8.60	11.70	-	0.11	0.39	3.50
06B-1*	D06101SS01	9.525	5.72	6.35	8.20	3.28	13.50	16.80	-	0.28	0.44	6.65
08B-1	D08301SS01	12.70	7.75	8.51	11.80	4.45	17.00	20.90	-	0.50	0.70	12.00
10B-1	D10101SS01	15.875	9.65	10.16	14.70	5.08	19.60	23.70	-	0.67	0.92	15.00
12B-1	D12001SS01	19.05	11.68	12.07	16.10	5.72	22.70	27.30	-	0.88	1.12	17.00
16B-1	D160 01SS 01	25.40	17.02	15.88	21.00	8.27	36.10	41.50	-	2.07	2.59	40.00

DOUBLE STRAND

06B-2*	D06102SS01	9.525	5.72	6.35	8.20	3.28	23.80	27.10	10.24	0.56	0.74	10.50
08B-2	D08302SS01	12.70	7.75	8.51	11.80	4.45	31.00	34.90	13.92	1.00	1.40	22.00
10B-2	D10102SS01	15.875	9.65	10.16	14.70	5.08	36.20	40.30	16.59	1.34	3.00	28.45
12B-2	D12002SS01	19.05	11.68	12.07	16.10	5.72	42.20	46.80	19.46	1.76	2.21	37.25
16B-2	D160 02 SS 01	25.40	17.02	15.88	21.00	8.27	68.00	73.40	31.88	4.14	5.08	74.45

TRIPLE STRAND

06B-3*	D06103SS01	9.525	5.72	6.35	8.20	3.28	34.00	37.30	10.24	0.84	1.11	17.85
08B-3	D08303SS01	12.70	7.75	8.51	11.80	4.45	44.90	48.80	13.92	1.00	1.31	35.30
10B-3	D10103SS01	15.875	9.65	10.16	14.70	5.08	52.80	56.90	16.59	1.34	1.79	42.65
12B-3	D12003SS01	19.05	11.68	12.07	16.10	5.72	61.70	66.30	19.46	1.76	2.22	50.05
16B-3	D160 03 SS 01	25.40	17.02	15.88	21.00	8.27	99.90	105.30	31.88	4.14	5.03	117.65

* Straight Contour

Note : Straight side Plate Stainless Steel Chains are also available.
Spares available for all models.

CORROSION RESISTANT CHAINS

STAINLESS STEEL CHAINS - AMERICAN SERIES

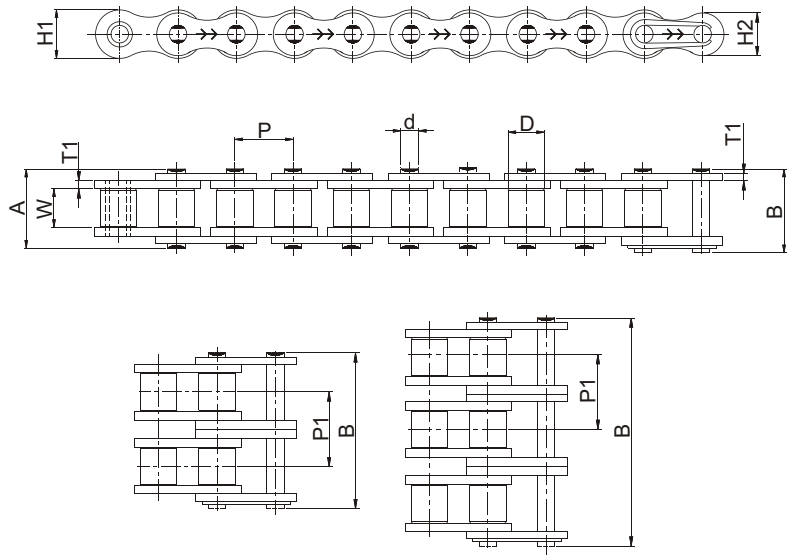

SINGLE STRAND

Intl Ref. No.	Rombo Chain No.	Pitch (P)	Width Between Inner Plates (W) (Min)	Roller Dia (D) (Max)	Plate Height		Plate Thickness		Bearing Pin Dia (d) (Max)	Width Over Bearing Pin (A) (Max)	Width Over Joining Fasteners (B) (Max)	Transverse Pitch (P1)	Projected Bearing Area (Sq.cm)	Avg. Weight Per Metre (Kg)	Tensile Strength (KN) (Min)
					IP H1 (Max)	OP H2 (Max)	IP T1	OP T2							
35-1	B 06A 01 SS 01	9.525	4.68	5.08	8.65	7.48	1.25	1.25	3.59	12.18	13.18	-	0.27	0.33	6.00
40-1	D 08A 01 SS 01	12.70	7.85	7.92	12.00	10.40	1.50	1.50	3.96	17.80	21.80	-	0.44	0.63	11.00
50-1	D 102 01 SS 01	15.875	9.40	10.16	15.00	13.00	2.00	2.00	5.08	21.80	25.90	-	0.71	1.04	17.00
60-1	D 121 01 SS 01	19.05	12.58	11.91	18.00	16.60	2.40	2.40	5.94	26.90	31.50	-	1.04	1.53	24.80
80-1	D 161 01 SS 01	25.40	15.75	15.88	24.10	20.80	3.00	3.00	7.92	33.50	38.90	-	1.77	2.59	41.00

DOUBLE STRAND

40-2	D 08A 02 SS 01	12.70	7.85	7.92	12.00	10.40	1.50	1.50	3.96	32.30	36.20	14.38	0.88	1.25	22.00
50-2	D 102 02 SS 01	15.875	9.40	10.16	15.00	13.00	2.00	2.00	5.08	37.90	44.00	18.11	1.42	2.05	34.00
60-2	D 121 02 SS 01	19.05	12.58	11.91	18.00	16.60	2.40	2.40	5.94	49.80	54.40	22.78	2.08	3.01	49.60
80-2	D 161 02 SS 01	25.40	15.75	15.88	24.10	20.80	3.00	3.00	7.92	62.70	68.10	29.29	3.54	4.17	82.00

TRIPLE STRAND

40-3	D 08A 03 SS 01	12.70	7.85	7.92	12.00	10.40	1.50	1.50	3.96	45.30	49.20	14.38	1.32	1.90	33.00
50-3	D 102 03 SS 01	15.875	9.40	10.16	15.00	13.00	2.00	2.00	5.08	56.80	60.90	18.11	2.13	3.12	51.00
60-3	D 121 03 SS 01	19.05	12.58	11.91	18.00	16.60	2.40	2.40	5.94	72.60	77.20	22.78	3.12	4.58	74.40
80-3	D 161 03 SS 01	25.40	15.75	15.88	24.10	20.80	3.00	3.00	7.92	91.90	97.10	29.29	5.31	6.04	123.00

Note: Spares available for all models.

CORROSION RESISTANT CHAINS

STAINLESS STEEL CHAINS DOUBLE PITCH - EUROPEAN SERIES

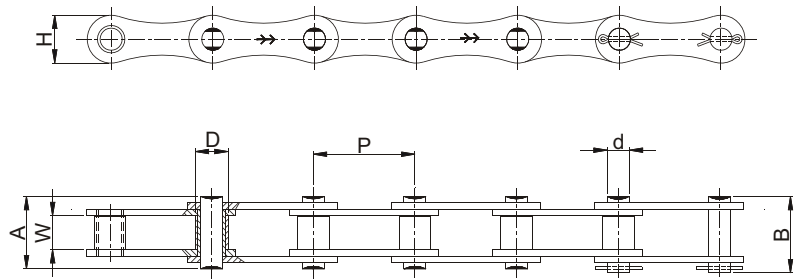

Intl. Ref. No.	ROMBO Chain No.	Pitch (P)	Width between Inner Plates (W) (Min)	Roller Dia (D) (Max)	Plate Height (H) (Max)	Bearing Pin Dia (d) (Max)	Width Over Bearing Pin (A) (Max)	Width Over Joint Fasteners (B) (Max)	Avg. Weight Per Metre (Kg)	Tensile Strength (KN) (Min)
208B-SS	E08301SS01	25.40	7.75	8.51	11.66	4.45	17.00	20.90	0.48	12.00
210B-SS	E10101SS01	31.75	9.65	10.16	13.90	5.08	19.60	23.70	0.69	15.00
212B-SS	E12001SS01	38.10	11.68	12.01	15.30	5.72	22.70	27.30	0.72	17.00
216B-SS	E16001SS01	50.80	17.02	15.88	20.65	8.27	36.10	41.50	1.30	40.00

Note: Spares available for all models.

CORROSION RESISTANT CHAINS

STAINLESS STEEL CHAINS DOUBLE PITCH - AMERICAN SERIES

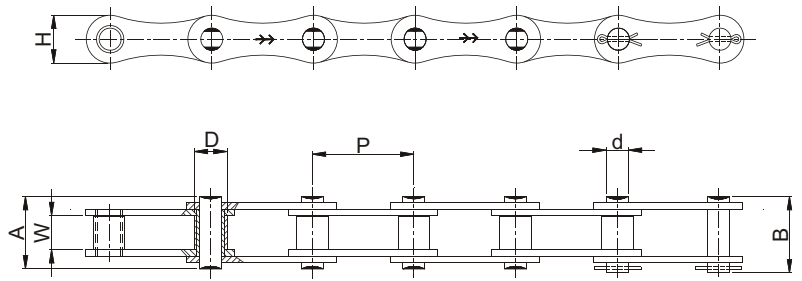

Intl Ref. No.	Rombo Chain No.	Pitch (P)	Width between Inner Plates (W) (Min)	Roller Dia (D) (Max)	Plate Height (H) (Max)	Bearing Pin Dia (d) (Max)	Width Over Bearing Pin (A) (Max)	Width Over Joint Fasteners (B) (Max)	Avg. Weight Per Metre (kg)	Tensile Strength (KN) (Min)
A 2040	E08A 01SS 01	25.40	7.85	7.92	11.66	3.96	17.80	21.80	0.41	11.00
A 2050	E102 01 SS 01	31.75	9.40	10.16	13.90	5.08	21.80	25.90	0.66	17.00
A 2060	E121 01 SS 01	38.10	12.58	11.91	18.18	5.94	26.90	31.50	1.03	24.80
A 2080	E161 01 SS 01	50.80	15.75	15.88	24.10	7.92	33.50	38.90	1.62	41.00

Spares available

CORROSION RESISTANT CHAINS

STAINLESS STEEL CHAINS DOUBLE PITCH AMERICAN SERIES - CONVEYOR

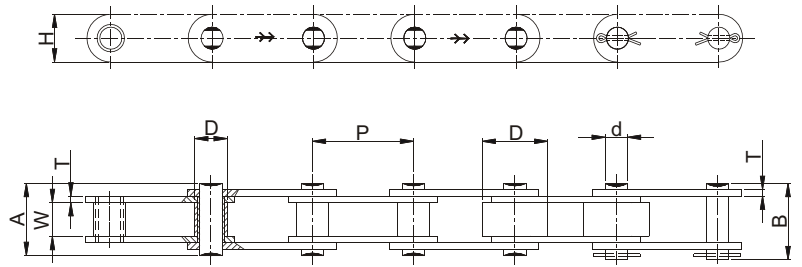

Intl Ref. No.	Rombo Chain No.	Pitch (P)	Width between Inner Plates (W) (Min)	Roller Dia (D) (Max)	Plate Height (H) (Max)	Plate Thickness (T)	Bearing Pin Dia (D) (Max)	Width Over Bearing Pin (A) (Max)	Width Over Joint Fasteners (B) (Max)	Projected Bearing Area (Sq.cm)	Avg. Weight Per Metre (Kg)	Tensile Strength (KN) (Min)
C 2040	A 08A 01 SS 01	25.40	7.85	7.92	11.66	1.50	3.96	17.80	21.80	0.44	0.48	11.00
C2042	A 08A 02 SS 01			15.88							0.82	
C2050	A 102 01 SS 01	31.75	9.40	10.16	14.58	2.00	5.08	20.80	25.90	0.71	0.82	17.00
C2052	A 102 02 SS 01			19.05							1.26	
C2060	A 121 01 SS 01	38.10	12.58	11.91	18.06	2.40	5.94	26.90	31.50	1.04	1.03	24.80
C2062	A 121 02 SS 01			22.22							1.47	
C2080	A 161 01 SS 01	50.80	15.75	15.88	24.05	3.00	7.92	33.50	38.90	1.77	2.00	41.00
C2082	A 161 02 SS 01			28.58							3.03	

Note: Spares available for all models.

ZAC CHAINS

ZAC chains are built to provide outstanding corrosion resistance, with the same strength and breaking load values of standard chains. A special coating fights corrosion in the most aggressive environments. ZAC chain superiority has been proven against Nickel, Zinc and other plated chains.

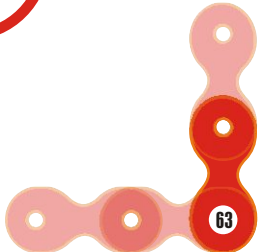

CORROSION RESISTANT CHAINS

PLATED CHAINS - EUROPEAN SERIES

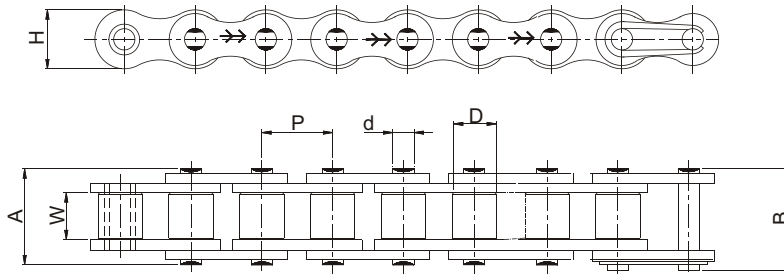

Nickel Plated Chains : These chains are ideal for use in light corrosive atmosphere or where good appearance is required.

Zinc Plated Chains : These chains are used in corrosive atmosphere and outdoor applications.

ZAC Chains : Excellent corrosion resistance with same strength and breaking load values as standard chains. The chains are designed to withstand a minimum of 250 hrs of salt spray testing as per ASTM B 117.

Intl Ref. No.	Pitch (P)	Width between Inner Plates (W) (Min)	Roller Dia (D) (Max)	Plate Height (H) (Max)	Bearing Pin Dia (d) (Max)	Width Over Bearing Pin (A) (Max)	Width Over Joint Fasteners (B) (Max)	Projected Bearing Area (Sq.cm)	Avg. Weight Per Metre (kg)	Tensile Strength (KN) (Min)		
										NP	ZP	ZAC
04B-1	6.00	2.80	4.00	5.00	1.85	7.40	10.30	0.08	0.12	3.00	2.55	3.00
05B-1	8.00	3.00	5.00	7.10	2.31	8.60	11.70	0.11	0.18	5.00	4.25	5.00
06B-1*	9.525	5.72	6.35	8.20	3.28	13.50	16.80	0.28	0.40	9.00	7.65	9.00
08B-1	12.70	7.75	8.51	11.80	4.45	17.00	20.90	0.50	0.68	18.00	15.30	18.00
10B-1	15.875	9.65	10.16	14.70	5.08	19.60	23.70	0.67	0.91	22.40	19.04	22.40
12B-1	19.05	11.68	12.07	16.10	5.72	22.70	27.30	0.88	1.12	29.00	24.65	29.00
16B-1	25.40	17.02	15.88	21.00	8.27	36.10	41.50	2.07	2.59	60.00	51.00	60.00

* Straight Sided Plate

Note:

NP - Nickel Plated

ZP - Zinc Plated

ZAC - Special Coating For High Corrosion Resistance

Also available with straight side plates and in Double, Triple strands.

CORROSION RESISTANT CHAINS

PLATED CHAINS - AMERICAN SERIES

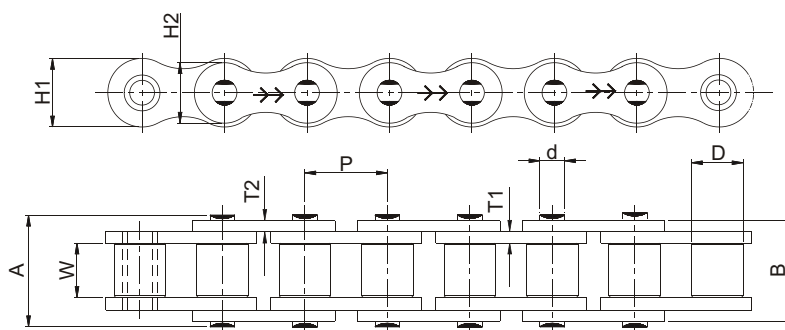

Nickel Plated Chains : These chains are ideal for use in light corrosive atmosphere or where good appearance is required.

Zinc Plated Chains : These chains are used in corrosive atmosphere and outdoor applications.

ZAC Chains : Excellent corrosion resistance with same strength and breaking load values as standard chains. The chains are designed to withstand a minimum of 250 hrs of salt spray testing as per ASTM B 117.

Intl Ref. No.	Pitch (P)	Width between Inner Plates (W) (Min)	Roller Dia (D) (Max)	Plate Height		Plate Thickness		Bearing Pin Dia (d) (Max)	Width Over Bearing Pin (A) (Max)	Width Over Joint Fasteners (B) (Max)	Projected Bearing Area (Sq.cm)	Avg. Weight Per Metre (kg)	Tensile Strength (KN) (Min)		
				IP (H1) (Max)	OP (H2) (Max)	IP (T1)	OP (T2)						NP	ZP	ZAC
25-1	6.35	3.18	3.30	5.80	5.25	0.75	0.75	2.31	7.80	9.60	0.11	0.13	3.47	2.95	3.47
35-1	9.525	4.68	5.08	8.65	7.48	1.25	1.25	3.59	12.18	13.18	0.27	0.34	7.80	6.65	7.8
40-1	12.70	7.85	7.92	12.00	10.41	1.50	1.50	3.96	17.80	21.70	0.44	0.63	14.1	12.00	14.1
41-1	12.70	6.30	7.80	9.60	8.30	1.30	1.30	3.60	14.80	18.70	0.30	0.40	6.70	5.70	6.70
50-1	15.875	9.40	10.16	15.00	13.00	2.00	2.00	5.08	21.80	25.90	0.71	1.04	22.20	18.90	22.20
60-1	19.05	12.58	11.91	18.00	16.60	2.39	2.39	5.94	26.90	31.50	1.04	1.52	31.80	27.00	31.8
80-1	25.40	15.75	15.88	24.10	20.80	3.15	3.15	7.92	33.50	38.90	1.77	3.08	56.70	48.20	56.7

Note:

NP - Nickel Plated

ZP - Zinc Plated

ZAC - Special Coating For High Corrosion Resistance

Also available with straight side plates and in Double, Triple strands.

LEAF LEAF CHAINS



LEAF

CHAIN S

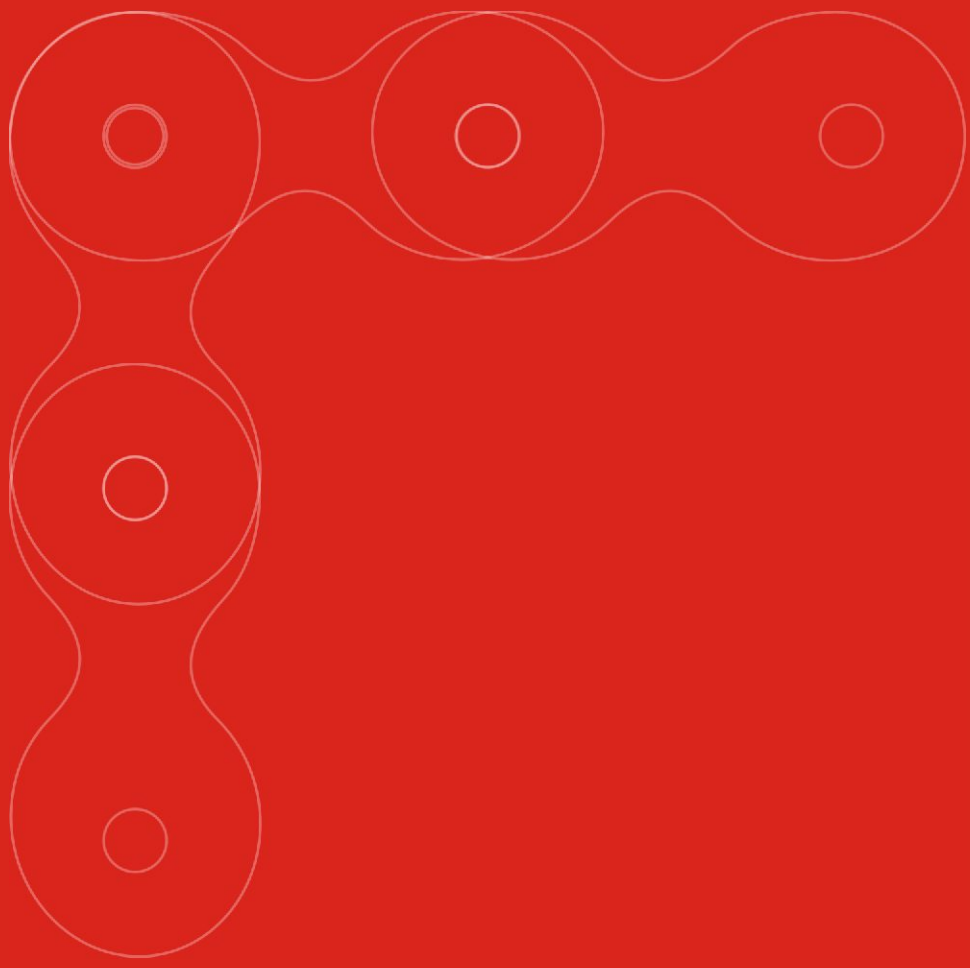

LEAF CHAINS

BL SERIES

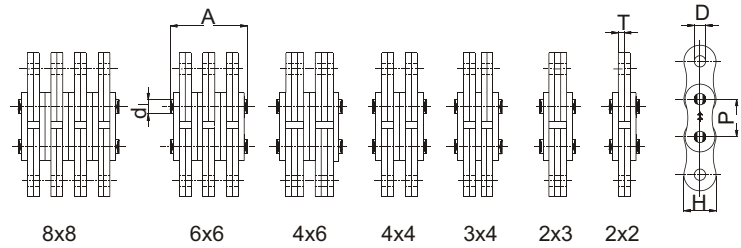

ISO 4347/ DIN 8152/ANSI B29.8

The BL series leaf chains are designed for medium loads and greater shocks for applications in lift trucks, masts, construction and mining.

Intl. Ref. No.	ROMBO Chain No.	Lacing Pattern	Pitch (P)	Pin Dia (d) (Max)	Plate Height (H) (Max)	Plate Thickness (T) (Max)	Hole Dia (D) (Min)	Width Over Bearing Pin (A) (Max)	Avg. Weight Per Metre (Kg)	Tensile Strength (KN) (Min)
BL 422	BL 08 22	2 x 2						11.00	0.59	22.24
BL 423	BL 08 23	2 x 3						13.10	0.75	22.24
BL 434	BL 08 34	3 x 4						17.40	1.03	33.40
BL 444	BL 08 44	4 x 4	12.700	5.09	12.07	2.08	5.12	19.50	1.16	44.50
BL 446	BL 08 46	4 x 6						23.75	1.47	44.50
BL 466	BL 08 66	6 x 6						27.99	1.72	66.72
BL 488	BL 08 88	8 x 8						36.40	2.29	89.00
BL 522	BL 10 22	2 x 2						12.88	0.86	33.40
BL 523	BL 10 23	2 x 3						15.30	1.09	33.40
BL 534	BL 10 34	3 x 4						20.30	1.50	50.10
BL 544	BL 10 44	4 x 4	15.875	5.96	15.09	2.44	5.98	22.70	1.68	66.80
BL 546	BL 10 46	4 x 6						27.70	2.15	66.80
BL 566	BL 10 66	6 x 6						32.10	2.51	100.20
BL 588	BL 10 88	8 x 8						42.50	3.33	133.60
BL 622	BL 12 22	2 x 2						17.30	1.39	48.93
BL 623	BL 12 23	2 x 3						20.70	1.76	48.93
BL 634	BL 12 34	3 x 4						27.40	2.43	75.62
BL 644	BL 12 44	4 x 4	19.050	7.94	18.10	3.30	7.96	30.70	2.72	97.90
BL 646	BL 12 46	4 x 6						37.40	3.46	97.90
BL 666	BL 12 66	6 x 6						44.20	4.05	146.80
BL 688	BL 12 88	8 x 8						57.60	5.38	195.72

Intl. Ref. No.	ROMBO Chain No.	Lacing Pattern	Pitch (P)	Pin Dia (d) (Max)	Plate Height (H) (Max)	Plate Thickness (T) (Max)	Hole Dia (D) (Min)	Width Over Bearing Pin (A) (Max)	Avg. Weight Per Metre (Kg)	Tensile Strength (KN) (Min)
BL 822	BL 16 22	2 x 2						21.30	2.53	84.52
BL 823	BL 16 23	2 x 3						25.40	3.09	84.52
BL 834	BL 16 34	3 x 4						33.70	4.26	129.00
BL 844	BL 16 44	4 x 4	25.40	9.54	24.10	4.09	9.56	37.90	4.78	169.03
BL 846	BL 16 46	4 x 6						46.10	6.10	169.03
BL 866	BL 16 66	6 x 6						54.40	7.13	253.60
BL 888	BL 16 88	8 x 8						71.00	9.47	338.10
BL 1022	BL 20 22	2 x 2						25.30	3.41	115.65
BL 1023	BL 20 23	2 x 3						30.30	4.23	115.65
BL 1034	BL 20 34	3 x 4						40.20	5.85	182.73
BL 1044	BL 20 44	4 x 4	31.750	11.11	30.18	4.90	11.14	45.10	6.69	231.30
BL 1046	BL 20 46	4 x 6						55.00	8.29	231.30
BL 1066	BL 20 66	6 x 6						65.00	9.92	347.00
BL 1088	BL 20 88	8 x 8						84.80	13.92	462.60
BL 1222	BL 24 22	2 x 2						29.60	5.00	151.24
BL 1223	BL 24 23	2 x 3						35.40	6.22	151.24
BL 1234	BL 24 34	3 x 4						47.00	8.62	244.64
BL 1244	BL 24 44	4 x 4	38.100	12.71	36.20	5.77	12.74	52.80	9.84	302.50
BL 1246	BL 24 46	4 x 6						64.50	12.26	302.50
BL 1266	BL 24 66	6 x 6						76.10	14.50	453.70
BL 1288	BL 24 88	8 x 8						99.40	19.54	605.00
BL 1422	BL 28 22	2 x 2						33.50	6.32	191.30
BL 1423	BL 28 23	2 x 3						40.10	7.91	191.30
BL 1434	BL 28 34	3 x 4						53.30	11.10	315.81
BL 1444	BL 28 44	4 x 4	44.450	14.29	42.20	6.55	14.31	59.50	12.62	382.60
BL 1446	BL 28 46	4 x 6						73.10	16.69	382.60
BL 1466	BL 28 66	6 x 6						86.30	20.00	578.30
BL 1488	BL 28 88	8 x 8						112.30	25.28	765.20
BL 1622	BL 32 22	2 x 2						39.00	8.72	289.12
BL 1623	BL 32 23	2 x 3						46.50	12.68	289.12
BL 1634	BL 32 34	3 x 4						61.70	15.09	440.40
BL 1644	BL 32 44	4 x 4	50.800	17.46	48.26	7.52	17.49	69.20	17.81	578.30
BL 1646	BL 32 46	4 x 6						84.40	21.46	578.30
BL 1666	BL 32 66	6 x 6						99.50	25.71	867.40
BL 1688	BL 32 88	8 x 8						129.80	39.89	1156.50

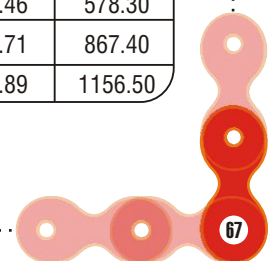

Intl. Ref. No.	ROMBO Chain No.	Lacing Pattern	Pitch (P)	Pin Dia (d) (Max)	Plate Height (H) (Max)	Plate Thickness (T) (Max)	Hole Dia (D) (Min)	Width Over Bearing Pin (A) (Max)	Avg. Weight Per Metre (Kg)	Tensile Strength (KN) (Min)
BL 2022	BL 40 22	2 x 2						51.70	15.80	433.68
BL 2023	BL 40 23	2 x 3						61.70	19.80	433.68
BL 2034	BL 40 34	3 x 4						81.60	27.70	650.60
BL 2044	BL 40 44	4 x 4	63.500	23.81	60.30	9.91	23.84	91.50	31.60	867.36
BL 2046	BL 40 46	4 x 6						111.40	39.50	867.40
BL 2066	BL 40 66	6 x 6						131.30	47.40	1301.20
BL 2088	BL 40 88	8 x 8						171.20	63.20	1734.80

Note : Connecting links & clevis pins are also available.

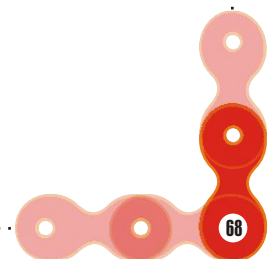

LEAF CHAINS

Superior plate geometry to withstand higher loads, superior hole preparation for better bearing contact with high tensile pins, just some of the characteristics that make these chains strong enough to exceed ISO, ANSI and other international specifications.

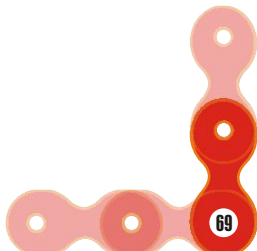
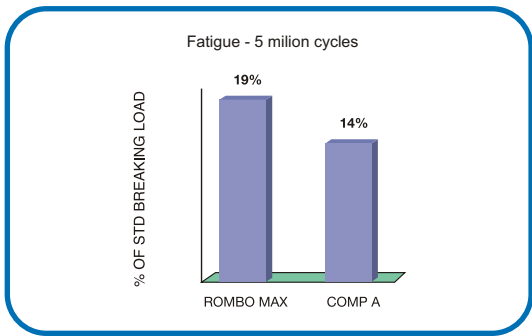
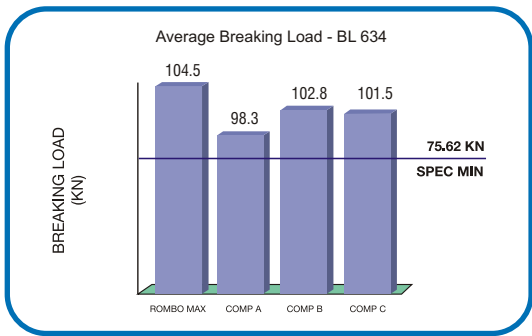

LEAF CHAINS

ROMBO MAX - BL SERIES



ISO 4347
DIN 8152 / ANSI B29.8

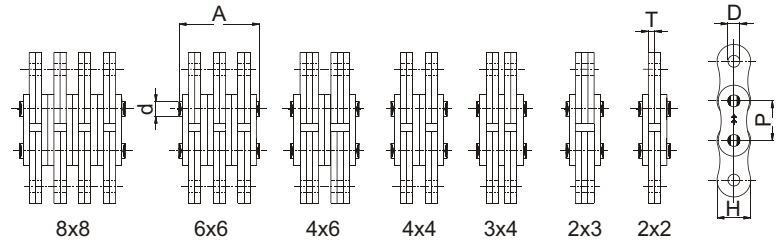

Intl. Ref. No.	ROMBO MAX Chain No.	Lacing Pattern	Pitch (P)	Pin Dia (d) (Max)	Plate Height (H) (Max)	Plate Thickness (T) (Max)	Hole Dia (D) (Min)	Width Over Bearing Pin (A) (Max)	Avg. Weight Per Metre (Kg)	ROMBO MAX Tensile Strength (KN) (Min)	ROMBO MAX Allowable Load (KN)
BL 422	Q - BL 08 22	2 x 2						11.00	0.67	28.00	4.45
BL 423	Q - BL 08 23	2 x 3						13.10	0.77	28.00	4.45
BL 434	Q - BL 08 34	3 x 4						17.40	1.07	42.00	6.68
BL 444	Q - BL 08 44	4 x 4	12.70	5.09	12.07	2.08	5.12	19.50	1.21	56.00	8.91
BL 446	Q - BL 08 46	4 x 6						23.75	1.51	56.00	8.91
BL 466	Q - BL 08 66	6 x 6						27.99	1.81	84.00	13.36
BL 488	Q - BL 08 88	8 x 8						36.40	2.41	112.00	17.81
BL 522	Q - BL 10 22	2 x 2						12.88	0.90	40.00	6.19
BL 523	Q - BL 10 23	2 x 3						15.30	1.11	40.00	6.19
BL 534	Q - BL 10 34	3 x 4						20.30	1.53	60.00	9.28
BL 544	Q - BL 10 44	4 x 4	15.875	5.96	15.09	2.44	5.98	22.70	1.75	80.00	12.37
BL 546	Q - BL 10 46	4 x 6						27.70	2.11	80.00	12.37
BL 566	Q - BL 10 66	6 x 6						32.10	2.60	120.00	18.56
BL 588	Q - BL 10 88	8 x 8						42.50	3.44	160.00	24.75
BL 622	Q - BL 12 22	2 x 2						17.30	1.47	68.67	9.59
BL 623	Q - BL 12 23	2 x 3						20.70	1.81	68.67	9.59
BL 634	Q - BL 12 34	3 x 4						27.40	2.50	103.00	14.38
BL 644	Q - BL 12 44	4 x 4	19.05	7.94	18.10	3.30	7.96	30.70	2.85	137.99	19.17
BL 646	Q - BL 12 46	4 x 6						37.40	3.55	137.99	19.17
BL 666	Q - BL 12 66	6 x 6						44.20	4.24	206.00	28.76
BL 688	Q - BL 12 88	8 x 8						57.60	5.63	254.96	38.35

Intl. Ref. No.	ROMBO MAX Chain No.	Lacing Pattern	Pitch (P)	Pin Dia (d) (Max)	Plate Height (H) (Max)	Plate Thickness (T) (Max)	Hole Dia (D) (Min)	Width Over Bearing Pin (A) (Max)	Avg. Weight Per Metre (Kg)	ROMBO MAX Tensile Strength (KN) (Min)	ROMBO MAX Allowable Load (KN)
BL 822	Q - BL 16 22	2 x 2						21.30	2.50	103.34	14.63
BL 823	Q - BL 16 23	2 x 3						25.40	3.10	103.34	14.63
BL 834	Q - BL 16 34	3 x 4						33.70	4.30	147.20	21.94
BL 844	Q - BL 16 44	4 x 4	25.40	9.54	24.10	4.09	9.56	37.90	4.80	206.69	29.25
BL 846	Q - BL 16 46	4 x 6						46.10	6.09	206.69	29.25
BL 866	Q - BL 16 66	6 x 6						54.40	7.29	314.11	43.88
BL 888	Q - BL 16 88	8 x 8						71.00	9.69	391.28	58.51

Note : Connecting links & clevis pins are also available

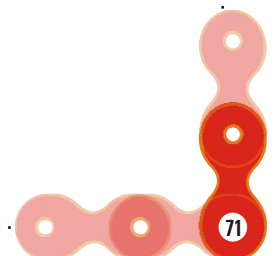

LEAF CHAINS

AL SERIES

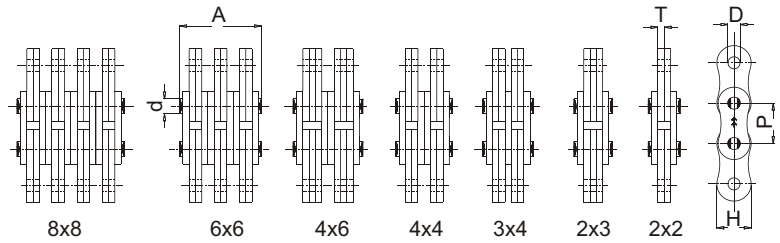

The AL series of leaf chains are used for light duty applications with relatively constant, low loads.

ROMBO Chain No.	Lacing Pattern	Pitch (P)	Pin Dia (d) (Max)	Plate Height (H) (Max)	Plate Thickness (T) (Max)	Hole Dia (D) (Min)	Width Over Bearing Pin (A) (Max)	Avg. Weight Per Metre (Kg)	Tensile Strength (KN) (Min)
AL 08 22	2 x 2						8.60	0.36	13.83
AL 08 23	2 x 3						10.20	0.46	13.83
AL 08 34	2 x 3						13.40	0.64	20.75
AL 08 44	4 x 4	12.70	3.98	12.07	1.61	4.01	15.00	0.74	27.66
AL 08 46	4 x 6						18.20	0.93	27.66
AL 08 66	6 x 6						21.40	1.10	41.40
AL 08 88	8 x 8						27.80	1.52	55.20
AL 10 22	2 x 2						10.85	0.65	26.48
AL 10 23	2 x 3						13.00	0.82	26.48
AL 10 34	3 x 4						17.20	1.11	39.72
AL 10 44	4 x 4	15.875	5.09	15.09	2.08	5.12	19.35	1.28	52.96
AL 10 46	4 x 6						23.60	1.63	52.96
AL 10 66	6 x 6						27.80	1.90	79.46
AL 10 88	8 x 8						36.35	2.60	105.94
AL 12 22	2 x 2						12.70	0.91	31.20
AL 12 23	2 x 3						15.20	1.13	31.20
AL 12 34	3 x 4						20.15	1.65	46.80
AL 12 44	4 x 4	19.05	5.96	18.10	2.44	5.98	22.65	1.79	62.40
AL 12 46	4 x 6						27.60	1.89	62.40
AL 12 66	6 x 6						32.55	2.66	93.60
AL 12 88	8 x 8						42.55	3.53	124.80

ROMBO Chain No.	Lacing Pattern	Pitch (P)	Pin Dia (d) (Max)	Plate Height (H) (Max)	Plate Thickness (T) (Max)	Hole Dia (D) (Min)	Width Over Bearing Pin (A) (Max)	Avg. Weight Per Metre (Kg)	Tensile Strength (KN) (Min)
AL 16 22	2 x 2						16.60	1.45	55.62
AL 16 23	2 x 3						19.75	1.85	55.62
AL 16 34	3 x 4						26.05	2.57	83.43
AL 16 44	4 x 4	25.40	7.94	24.10	3.30	7.96	29.30	2.85	111.25
AL 16 46	4 x 6						35.50	3.65	111.25
AL 16 66	6 x 6						41.90	4.24	166.87
AL 16 88	8 x 8						54.70	5.80	222.49
AL 20 22	2 x 2						21.30	2.31	93.20
AL 20 23	2 x 3						25.50	2.97	93.20
AL 20 34	3 x 4						33.70	4.13	139.80
AL 20 44	4 x 4	31.75	9.54	30.18	4.09	9.56	37.90	4.54	186.40
AL 20 46	4 x 6						46.10	5.86	186.40
AL 20 66	6 x 6						54.40	6.77	279.60
AL 20 88	8 x 8						72.00	9.24	354.04
AL 24 22	2 x 2						24.15	3.42	132.98
AL 24 23	2 x 3						28.90	4.52	132.98
AL 24 34	3 x 4						38.40	5.91	199.47
AL 24 44	4 x 4	38.10	11.11	36.20	4.90	11.14	43.15	6.74	265.96
AL 24 46	4 x 6						52.65	8.40	265.96
AL 24 66	6 x 6						64.37	9.71	399.08
AL 28 22	2 x 2						28.90	4.79	169.12
AL 28 23	2 x 3						34.70	5.95	169.12
AL 28 34	3 x 4						46.40	8.28	253.68
AL 28 44	4 x 4	44.45	12.71	36.20	5.77	12.74	52.20	9.45	338.24
AL 28 46	4 x 6						63.85	11.78	338.24
AL 28 66	6 x 6						75.50	14.11	522.10
AL 32 22	2 x 2						32.40	6.00	222.49
AL 32 23	2 x 3						39.00	7.56	222.49
AL 32 34	3 x 4						52.25	10.53	333.74
AL 32 44	4 x 4	50.80	14.29	42.20	6.55	14.31	58.90	11.95	451.10
AL 32 46	4 x 6						72.10	14.98	451.10
AL 32 66	6 x 6						85.35	17.95	667.47

Note : Connecting links & clevis pins are also available.

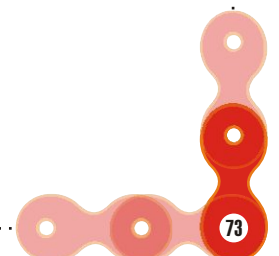

LEAF CHAINS

LL STANDARD SERIES



ISO 4347 / DIN 8152

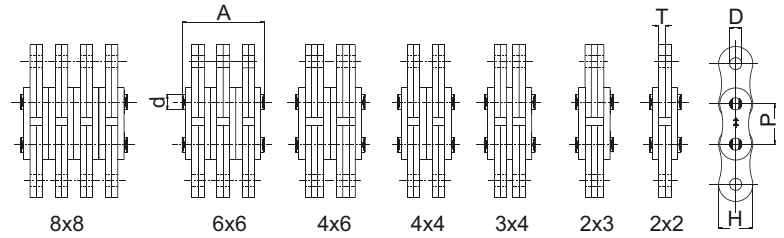

The LL series leaf chains are derived from European series chains and used in various lifting applications including lift trucks, masts and counter weights.

Intl. Ref. No.	ROMBO Chain No.	Lacing Pattern	Pitch (P)	Pin Dia (D) (Max)	Plate Height (H) (Max)	Plate Thickness (T) (Max)	Hole Dia (D) (Min)	Width Over Bearing Pin (A) (Max)	Avg. Weight Per Metre (Kg)	Tensile Strength (KN) (Min)
LL 08 22	DL 08 22 0001	2 x 2						9.20	0.39	18.20
LL 08 23	DL 08 23 0001	2 x 3						10.75	0.47	18.20
LL 08 34	DL 08 34 0001	3 x 4						14.25	0.66	27.30
LL 08 44	DL 08 44 0002	4 x 4	12.70	4.45	10.90	1.60**	4.46	16.00	0.75	36.40
LL 08 46	DL 08 46 0001	4 x 6						18.50	0.94	36.40
LL 08 66	DL 08 66 0003	6 x 6						22.80	1.12	54.60
LL 08 88	DL 08 88 0001	8 x 8						30.00	1.49	72.80
LL 10 22	LL 10 22	2 x 2						9.30	0.31	22.70
LL 10 23	LL 10 23	2 x 3						11.00	0.37	22.70
LL 10 34	LL 10 34	3 x 4						14.40	0.53	34.05
LL 10 44	LL 10 44	4 x 4	15.875	5.08	13.70	1.65	5.09	16.10	0.60	45.40
LL 10 46	LL 10 46	4 x 6						19.50	0.75	45.40
LL 10 66	LL 10 66	6 x 6						22.90	0.89	68.10
LL 10 88	LL 10 88	8 x 8						29.70	1.20	90.80
LL 12 22	LL 12 22	2 x 2						10.70	0.35	29.50
LL 12 23	LL 12 23	2 x 3						12.65	0.43	29.50
LL 12 34	LL 12 34	3 x 4						16.55	0.58	44.25
LL 12 44	LL 12 44	4 x 4	19.05	5.72	16.10	1.90	5.73	18.50	0.66	59.00
LL 12 46	LL 12 46	4 x 6						22.40	0.82	59.00
LL 12 66	LL 12 66	6 x 6						26.30	0.98	88.50
LL 12 88	LL 12 88	8 x 8						34.10	1.30	118.00

**Also available in 1.30 mm thickness

Intl. Ref. No.	ROMBO Chain No.	Lacing Pattern	Pitch (P)	Pin Dia (D) (Max)	Plate Height (H) (Max)	Plate Thickness (T) (Max)	Hole Dia (D) (Min)	Width Over Bearing Pin (A) (Max)	Avg. Weight Per Metre (Kg)	Tensile Strength (KN) (Min)
LL 16 22	LL 16 22	2 x 2						17.20	1.00	58.00
LL 16 23	LL 16 23	2 x 3						20.45	1.23	58.00
LL 16 34	LL 16 34	3 x 4						26.93	1.69	87.00
LL 16 44	LL 16 44	4 x 4	25.40	8.28	21.08	3.20	8.30	30.20	1.92	116.00
LL 16 46	LL 16 46	4 x 6						36.70	2.39	116.00
LL 16 66	LL 16 66	6 x 6						43.20	2.85	174.00
LL 16 88	LL 16 88	8 x 8						56.20	3.80	232.00
LL 20 22	LL 20 22	2 x 2						20.10	2.29	95.00
LL 20 23	LL 20 23	2 x 3						23.10	2.83	95.00
LL 20 34	LL 20 34	3 x 4						30.45	3.92	142.50
LL 20 44	LL 20 44	4 x 4	31.75	10.19	26.40	3.70	10.21	35.10	4.47	190.00
LL 20 46	LL 20 46	4 x 6						41.40	5.55	190.00
LL 20 66	LL 20 66	6 x 6						50.10	6.65	285.00
LL 20 88	LL 20 88	8 x 8						65.10	8.64	380.00
LL 24 22	LL 24 22	2 x 2						28.40	4.17	170.00
LL 24 23	LL 24 23	2 x 3						31.75	5.17	170.00
LL 24 34	LL 24 34	3 x 4						42.30	7.17	255.00
LL 24 44	LL 24 44	4 x 4	38.10	14.63	33.40	5.20	14.65	49.40	8.16	340.00
LL 24 46	LL 24 46	4 x 6						58.10	10.15	340.00
LL 24 66	LL 24 66	6 x 6						70.40	12.14	510.00
LL 24 88	LL 24 88	8 x 8						91.40	15.15	680.00
LL 28 22	LL 28 22	2 x 2						34.00	5.26	200.00
LL 28 23	LL 28 23	2 x 3						37.00	6.53	200.00
LL 28 34	LL 28 34	3 x 4						49.50	9.06	300.00
LL 28 44	LL 28 44	4 x 4	44.45	15.90	37.08	6.45	15.92	60.00	10.33	400.00
LL 28 46	LL 28 46	4 x 6						68.35	12.86	400.00
LL 28 66	LL 28 66	6 x 6						86.00	15.39	600.00
LL 32 22	LL 32 22	2 x 2						35.00	7.19	260.00
LL 32 23	LL 32 23	2 x 3						37.65	8.93	260.00
LL 32 34	LL 32 34	3 x 4						50.20	12.40	390.00
LL 32 44	LL 32 44	4 x 4	50.80	17.81	42.29	6.45	17.83	61.00	14.14	520.00
LL 32 46	LL 32 46	4 x 6						69.00	17.62	520.00
LL 32 66	LL 32 66	6 x 6						87.00	21.09	780.00

Note : Connecting links & clevis pins are also available

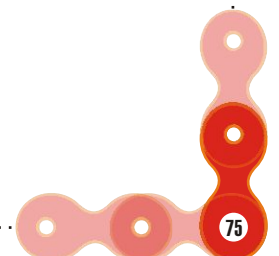

CONVEYOR CHAIN



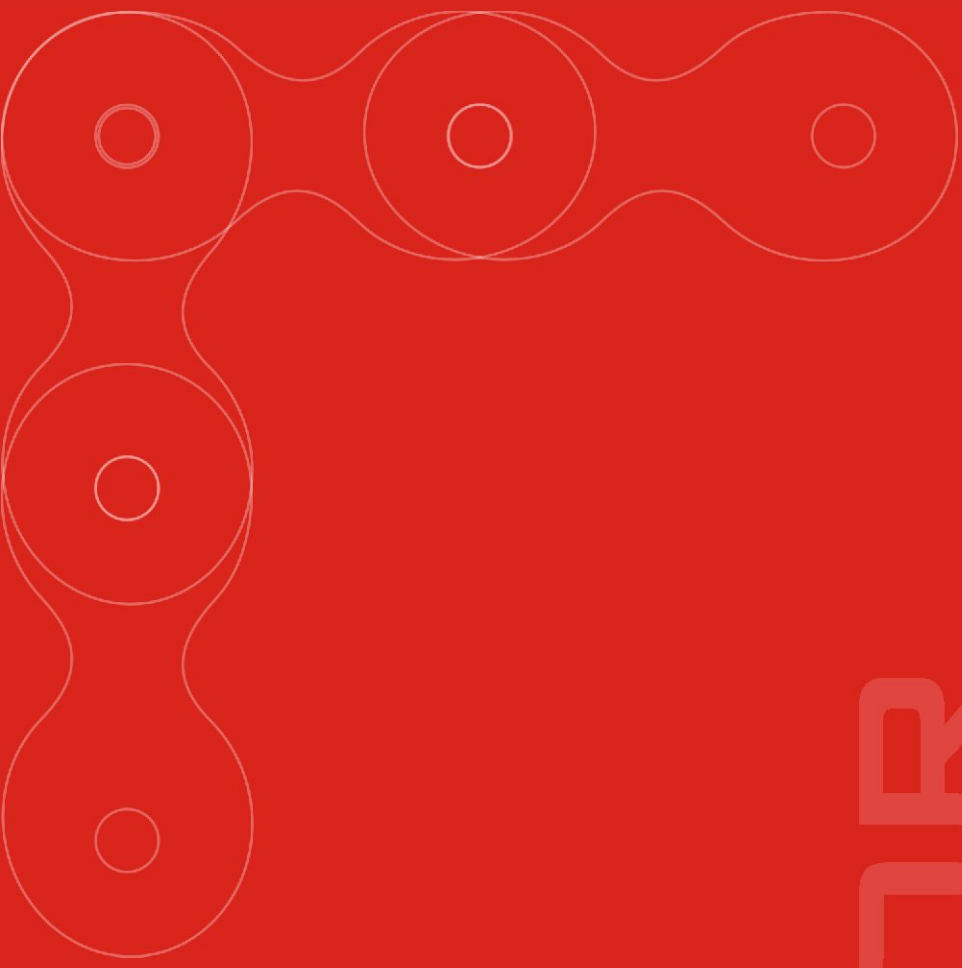

CONVEYOR

CHAINS

CONVEYOR CHAINS

EUROPEAN SERIES (BS) - SOLID PIN CHAINS

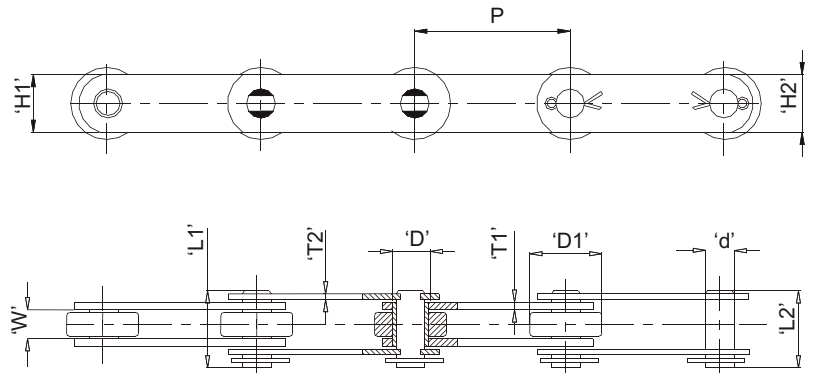

Minimum tensile Strength in lbs	Pitch ('P')		Width between Inner Plates (W) (Min)	Large roller Dia ('D1')	Bush Dia ('D')	Solid pin Dia ('d')	Solid pin length ('L1') (Max)	Connecting pin length ('L2') (Max)	Inner Plate		Outer Plate		Avg. Wt/Mtr in (Kg)
	INCH	METRIC							Height ('H1')	Thick ('T1')	Height ('H2')	Thick ('T2')	
7500	2.0	50.80	15.00	31.80	18.00	14.00	38.00	42.60	25.40	3.80	25.40	3.80	4.07
	2.5	63.50											3.59
	3.0	76.20											3.29
	4.0	101.60											2.88
	5.0	127.00											2.65
	6.0	152.40											2.49
15000	2.0	50.80	19.00	47.60	23.60	19.00	46.00	49.80	38.10	5.10	38.10	3.80	8.14
	3.0	76.20											7.77
	4.0	101.60											6.56
	5.0	127.00											5.85
	6.0	152.40											5.34
	7.0	177.80											5.00
	8.0	203.20											4.78
	9.0	228.60											4.53
30000	4.0	101.60	25.40	66.67	33.20	26.90	60.00	65.40	51.00	7.10	51.00	5.10	14.50
	5.0	127.00											12.65
	6.0	152.40											11.40
	7.0	177.80											10.52
	8.0	203.20											9.87
	9.0	228.60											9.34
	12.0	304.80											8.31

Minimum tensile Strength in lbs	Pitch ('P')		Width between Inner Plates (W) (Min)	Large roller Dia ('D1')	Bush Dia ('D')	Solid pin Dia ('d')	Solid pin length ('L1') (Max)	Connecting pin length ('L2') (Max)	Inner Plate		Outer Plate		Avg. Wt/Mtr in (Kg)
	INCH	METRIC							Height ('H1')	Thick ('T1')	Height ('H2')	Thick ('T2')	
	45000	5.0							127.00	38.10	88.90	38.10	
6.0		152.40	24.69										
7.0		177.80	22.31										
8.0		203.20	20.55										
9.0		228.60	19.21										
12.0		304.80	16.49										
60000	6.0	152.40	38.10	88.90	38.10	23.00	82.00	86.90	61.00	8.90	61.00	7.60	23.73
	7.0	177.80											21.96
	8.0	203.20											20.26
	9.0	228.60											18.94
	12.0	304.80											16.28
90000	6.0	152.40	38.10	88.90	38.10	29.40	94.00	98.60	63.50	13.00	63.50	10.00	29.61
	9.0	228.60											23.78
	12.0	304.80											20.87

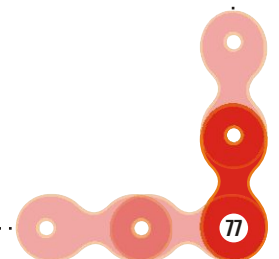

CONVEYOR CHAINS

EUROPEAN SERIES (BS) - HOLLOW PIN CHAINS

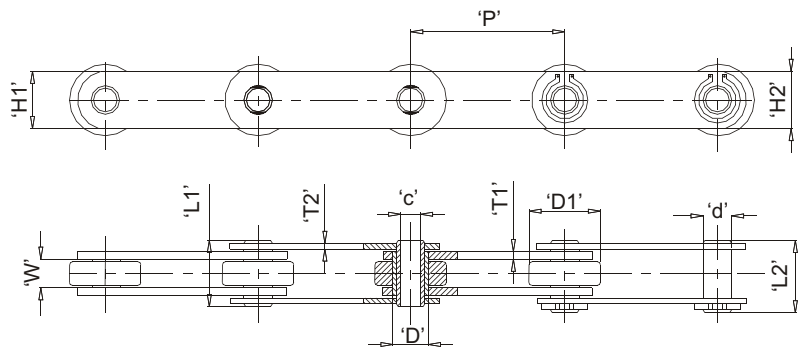

Minimum tensile Strength in lbs	Pitch		Width between Inner Plates ('W') (Min)	Large roller Dia ('D1')	Bush Dia ('D')	Hollow pin bore ('C') (Min)	Hollow pin Dia ('d')	Hollow pin length ('L1') (Max)	Connecting pin length ('L2') (Max)	Inner Plate		Outer Plate		Avg. Wt/Mtr In (Kg)
	('P')									Height ('H1')	Thick ('T1')	Height ('H2')	Thick ('T2')	
	INCH	METRIC												
6000	2.0	50.80	15.00	31.80	18.00	10.10	14.00	36.50	38.90	25.40	3.80	25.40	3.80	3.68
	2.5	63.50												3.29
	3.0	76.20												3.02
	4.0	101.60												2.71
	5.0	127.00												2.51
	6.0	152.40												2.38
12000	2.0	50.80	19.00	47.60	23.60	13.20	19.00	45.60	47.50	38.10	5.10	38.10	3.80	5.49
	3.0	76.20												7.28
	4.0	101.60												6.21
	5.0	127.00												5.57
	6.0	152.40												5.13
	7.0	177.80												4.83
	8.0	203.20												4.61
	9.0	228.60												4.42
24000	4.0	101.60	25.40	66.67	33.20	20.10	26.90	57.00	60.50	51.00	7.10	51.00	5.10	13.16
	5.0	127.00												11.58
	6.0	152.40												11.27
	7.0	177.80												9.77
	8.0	203.20												9.21
	9.0	228.60												8.78
	12.0	304.80												7.90

Minimum tensile Strength in lbs	Pitch		Width between Inner Plates ('W') (Min)	Large roller Dia ('D1')	Bush Dia ('D')	Hollow pin bore ('C') (Min)	Hollow pin Dia ('d')	Hollow pin length ('L1') (Max)	Connecting pin length ('L2') (Max)	Inner Plate		Outer Plate		Avg. Wt/Mtr In (Kg)
	('P')									Height ('H1')	Thick ('T1')	Height ('H2')	Thick ('T2')	
	INCH	METRIC												
36000	5.0	127.00	38.10	88.90	38.10	23.10	31.80	79.50	84.00	61.00	8.90	61.00	7.60	25.47
	6.0	152.40												22.62
	7.0	177.80												20.58
	8.0	203.20												19.05
	9.0	228.60												17.87
	12.0	304.80												15.49

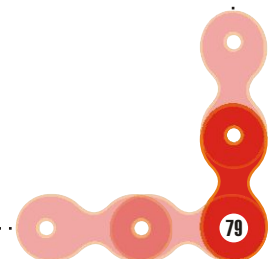

CONVEYOR CHAINS

METRIC SERIES (ISO) - SOLID PIN CHAINS

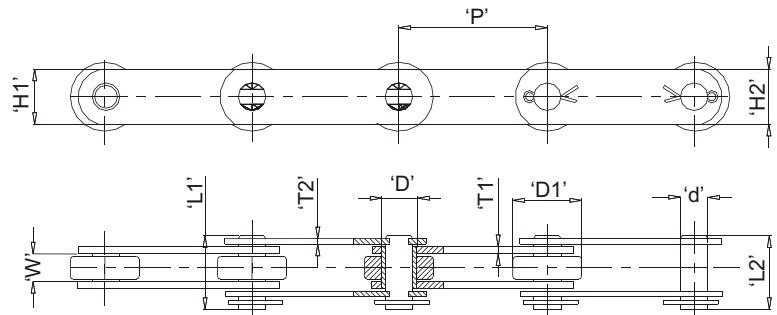

Minimum Tensile Strength in lbs	Pitch ('P')	Width between Inner Plates ('W') (Min)	Large roller Dia ('D1')	Bush Dia ('D')	Solid Pin Dia ('d')	Solid Pin length ('L1') (Max)	Connecting pin length ('L2') (Max)	Inner Plate		Outer Plate		Avg. Wt/Mtr in (Kg)
								Height ('H1')	Thick ('T1')	Height ('H2')	Thick ('T2')	
20000(M20)	50.00	16.00	25.00	9.00	6.00	30.50	33.10	18.00	2.50	18.00	2.50	2.02
	63.00											1.72
	80.00											1.51
	100.00											1.35
	125.00											1.22
	160.00											1.10
28000(M28)	63.00	18.00	30.00	10.00	7.00	35.00	37.50	20.00	3.00	20.00	3.00	2.74
	80.00											2.35
	100.00											2.07
	125.00											1.85
	160.00											1.65
	200.00											1.51
40000 (M40)	63.00	20.00	36.00	12.50	8.50	41.00	44.60	25.00	3.50	25.00	3.50	4.40
	80.00											3.76
	100.00											3.30
	125.00											2.93
	160.00											2.60
	200.00											2.36
	250.00											2.17

Minimum Tensile Strength in lbs	Pitch ('P')	Width between Inner Plates ('W') (Min)	Large roller Dia ('D1')	Bush Dia ('D')	Solid Pin Dia ('d')	Solid Pin length ('L1') (Max)	Connecting pin length ('L2') (Max)	Inner Plate		Outer Plate		Avg. Wt/Mtr in (Kg)
								Height ('H1')	Thick ('T1')	Height ('H2')	Thick ('T2')	
56000(M56)	80.00	24.00	42.00	15.00	10.00	46.50	52.30	30.00	4.00	30.00	4.00	5.63
	100.00											4.89
	125.00											4.30
	160.00											3.77
	200.00											3.41
	250.00											3.12
80000 (M80)	80.00	28.00	50.00	18.00	12.00	55.00	60.40	35.00	5.00	35.00	5.00	9.40
	100.00											8.07
	125.00											7.00
	160.00											6.07
	200.00											5.40
	250.00											4.87
	315.00											4.43
112000(M112)	100.00	32.00	60.00	21.00	15.00	63.50	70.30	40.00	6.00	40.00	6.00	11.45
	125.00											9.93
	160.00											8.59
	200.00											7.65
	250.00											6.89
	315.00											6.26
	400.00											5.74
160000 (M160)	160.00	37.00	70.00	25.00	18.00	73.50	81.20	50.00	7.00	50.00	7.00	13.41
	200.00											11.80
	250.00											10.51
	315.00											9.45
	400.00											8.59
224000(M224)	160.00	43.00	85.00	30.00	21.00	84.00	93.10	60.00	8.00	60.00	8.00	20.24
	200.00											17.71
	250.00											15.69
	315.00											14.01
	400.00											12.65
315000(M315)	200.00	48.00	100.00	36.00	25.00	97.00	107.00	70.00	10.00	70.00	10.00	29.35
	250.00											25.70
	315.00											22.70
	400.00											20.24
450000 (M450)	200.00	56.00	120.00	42.00	30.00	114.00	126.60	80.00	12.00	80.00	12.00	45.03
	250.00											39.06
	315.00											34.13
	400.00											30.11

Minimum Tensile Strength in lbs	Pitch ('P')	Width between Inner Plates ('W') (Min)	Large roller Dia ('D1')	Bush Dia ('D')	Solid Pin Dia ('d')	Solid Pin length ('L1') (Max)	Connecting pin length ('L2') (Max)	Inner Plate		Outer Plate		Avg. Wt/Mtr in (Kg)
								Height ('H1')	Thick ('T1')	Height ('H2')	Thick ('T2')	
630000 (M630)	250.00	66.00	140.00	50.00	36.00	133.00	145.00	100.00	14.00	100.00	14.00	61.00
	315.00											52.99
	400.00											46.46
900000(M900)	315.00	78.00	170.00	60.00	44.00	153.00	169.60	120.00	16.00	120.00	16.00	84.16
	400.00											72.72

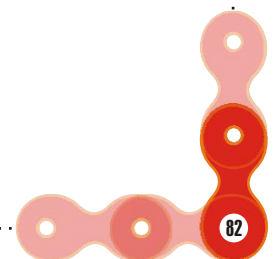

CONVEYOR CHAINS



METRIC SERIES (ISO) - HOLLOW PIN CHAINS

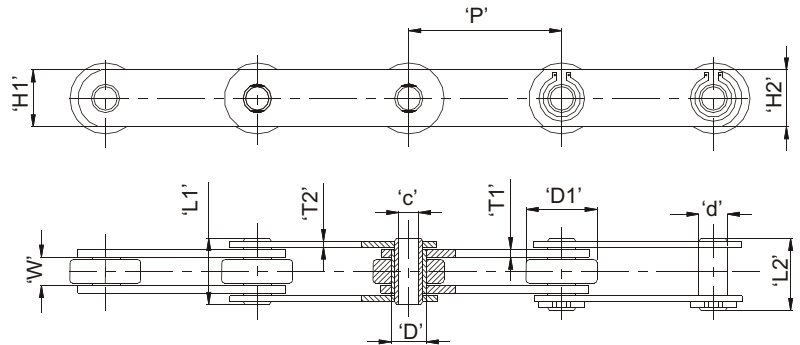

Minimum Tensile Strength In lbs	Pitch ('P')	Width between Inner Plates ('W') (Min)	Large Roller Dia ('D1')	Bush Dia ('D')	Hollow Pinbore ('C') (Min)	Hollow Pin Dia ('d')	Hollow Pin Length ('L1') (Max)	Connecting Pin Length ('L2') (Max)	Inner Plate		Outer Plate		Avg. Wt/Mtr in (Kg)
									Height ('H1')	Thick ('T1')	Height ('H2')	Thick ('T2')	
28000(MC28)	63.00	20.00	17.50	36.00	8.20	13.00	40.50	43.90	25.00	3.50	25.00	3.50	3.95
	80.00												3.44
	100.00												3.04
	125.00												2.71
	160.00												2.43
56000 (MC56)	80.00	24.00	21.00	50.00	10.20	15.50	46.50	50.00	35.00	4.00	35.00	4.00	6.79
	100.00												5.87
	125.00												5.14
	160.00												4.52
	200.00												4.07
	250.00												3.71
112000 (MC112)	100.00	32.00	29.00	70.00	14.30	22.00	63.00	69.90	50.00	6.00	50.00	6.00	15.16
	125.00												13.04
	160.00												11.16
	200.00												9.82
	250.00												8.75
	315.00												7.87
224000 (MC224)	160.00	43.00	41.00	100.00	20.30	31.00	83.00	92.10	70.00	8.00	70.00	8.00	21.96
	200.00												18.85
	250.00												16.38
	350.00												14.32
	400.00												12.64

WORK STANDARD ENGINEERING CLASS CHAINS



VERTI CHAIN WITH BI-PLANAR ATTACHMENT AND TROLLEY



OFFSET SIDE BAR CHAIN FOR CONSTRUCTION EQUIPMENT



BUCKET ELEVATOR CHAIN FOR CEMENT PLANT

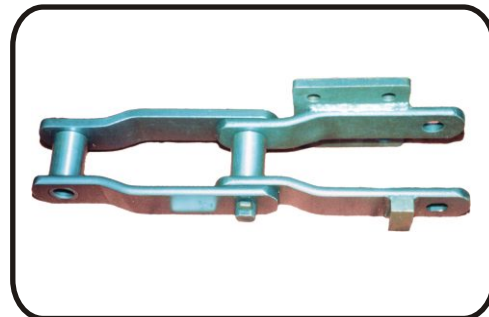

BUCKET ELEVATOR CHAIN FOR FERTILIZER INDUSTRY

AUTOMOTIVE CHAINS

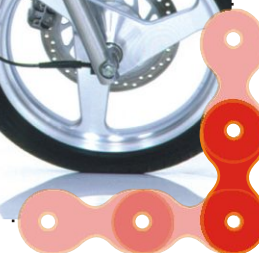

AUTOMOTIVE

CHAINS

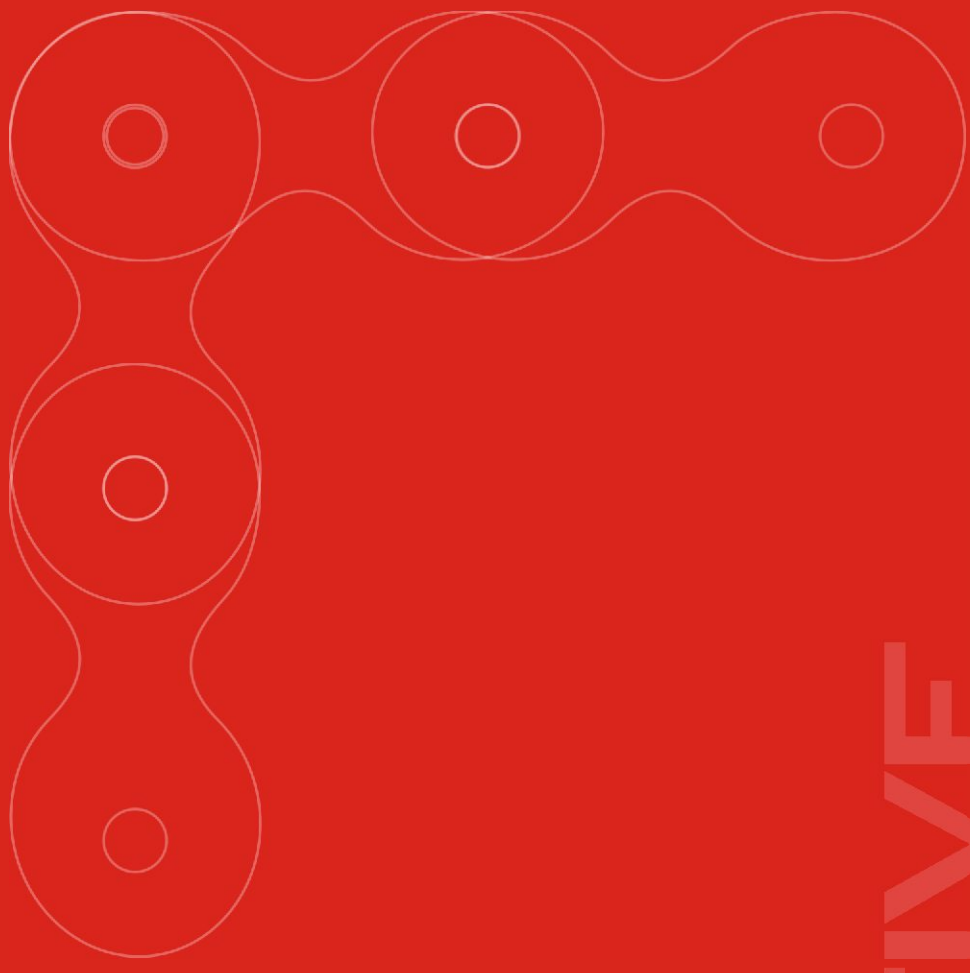

AUTOMOTIVE CHAINS

MOTORCYCLE DRIVE CHAINS

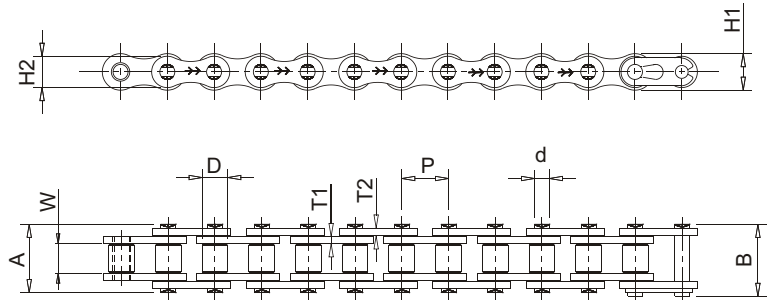

Rombo Motorcycle drive chains are precision engineered to offer excellent performance in terms of low wear and long life.

Intl Ref. No.	ROMBO Chain No.	Pitch (P)	Width between Inner Plates (W) (Min)	Roller Diameter (D) (Max)	Plate Height		Plate Thickness		Bearing Pin Diameter (D) (Max)	Width Over Bearing Pin (A) (Max)	Width Over Joint Fasteners (B) (Max)	Average Weight Per Metre (Kg)	Tensile Strength (KN) (Min)
					IP	OP	IP	OP					
					(H1) (Max)	(H2) (Max)	(T1) (Max)	(T2) (Max)					
J415	D 087 01	12.70	5.15	7.75	10.57	10.57	1.37	1.37	4.07	13.16	14.30	0.476	13.73
J415H	D 08K 01	12.70	5.01	7.75	10.57	10.57	1.76	1.50	4.07	14.05	15.20	0.554	15.69
J415R	D 08M 01	12.70	5.01	7.75	9.90	9.00	1.76	1.58	4.07	14.30	15.40	0.500	15.69
J420	D 088 01	12.70	6.35	7.77	11.56	10.57	1.50	1.50	3.96	14.80	16.40	0.583	15.69
J428	D 089 01	12.70	7.95	8.51	11.56	10.57	1.58	1.50	4.47	16.80	19.00	0.693	18.63
J428H	D 08E 01	12.70	7.85	8.51	11.75	10.20	2.00	2.00	4.46	18.90	21.05	0.848	20.59
J520	D 105 01	15.875	6.35	10.16	14.48	13.51	2.00	2.00	5.07	17.44	18.90	0.944	26.48
J525	D 104 01	15.875	7.94	10.16	14.48	13.51	2.00	2.00	5.07	18.95	20.40	1.007	26.48
J530	D 102 01	15.875	9.40	10.16	14.48	13.51	2.00	2.00	5.07	21.80	24.30	1.055	26.48
J520M	D 105 A2	15.875	6.35	10.16	15.00	12.92	2.00	2.00	5.25	17.44	18.90	1.025	26.48

 WORK STANDARD DRIVE CHAINS

ROMBO Chain No.	Pitch (P)	Width between Inner Plates (W) (Min)	Roller Diameter (D) (Max)	Plate Height		Plate Thickness		Bearing Pin Diameter (D) (Max)	Width Over Bearing Pin (A) (Max)	Width Over Joint Fasteners (B) (Max)	Average Weight Per Metre (Kg)	Tensile Strength KN (Min)
				IP (H1) (Max)	OP (H2) (Max)	IP (T1) (Max)	OP (T2) (Max)					
D 084 01	12.70	4.88	7.75	10.20	9.10	1.25	1.20	4.07	12.35	13.85	0.630	12.01
D 086 01	12.70	2.38	7.75	9.86	8.18	1.00	1.00	3.62	8.20	-	1.265	8.04
D 08C 01	12.70	3.30	7.75	9.47	8.18	1.00	1.00	3.62	10.20	11.70	0.289	8.04
D 08D 01	12.70	6.25	7.77	9.47	8.18	1.25	1.25	3.58	14.80	18.70	0.437	8.92
D 08F 01	12.70	7.77	4.80	11.56	10.57	1.50	1.50	3.96	13.45	15.15	0.578	15.69
D 08L 01	12.70	5.15	7.75	9.90	9.00	1.50	1.37	4.07	13.16	14.30	0.450	13.73
D 08N 01	12.70	7.95	8.50	11.75	10.20	1.76	1.76	4.50	17.70	18.95	0.760	20.59
D 08P 01	12.70	5.15	7.68	11.56	10.57	1.00	1.00	4.07	12.10	13.00	0.717	11.77
D 08Q 01	12.70	7.95	8.50	11.56	10.57	1.76	1.76	5.00	17.70	18.95	0.784	20.59
D 08R 01	12.70	7.95	8.51	12.00	10.80	1.75	1.75	4.50	17.70	18.95	0.794	18.63
D 08S 01	12.70	7.95	8.50	11.56	10.57	1.58	1.50	5.00	16.72	19.05	0.723	17.65
D 08T 01	12.70	7.85	8.51	11.75	10.20	2.00	2.00	5.00	18.90	21.05	0.845	20.59
S 08M 01	12.70	5.01	7.75	10.57	10.57	1.50	1.50	4.44	14.00	15.00	0.750	15.69
B 103 01	15.875	11.40	10.08*	16.58	16.58	2.44	2.85	7.00	31.15	31.85	2.087	46.09
B 104 01	15.875	7.95	10.16*	14.48	-	2.00	2.00	5.07	18.90	20.35	2.510	27.46
D 101 01	15.875	9.65	10.16	14.48	13.51	1.58	1.58	5.07	19.60	23.70	0.921	22.46
D 105 A1	15.875	6.35	10.16	15.00	13.00	2.00	2.00	5.20	17.95	19.40	1.011	31.38

Grand Prix Chains

Intl Ref. No.	ROMBO Chain No.	Pitch (P)	Width between Inner Plates (W) (Min)	Roller Diameter (D) (Max)	Plate Height		Plate Thickness		Bearing Pin Diameter (D) (Max)	Width Over Bearing Pin (A) (Max)	Width Over Joint Fasteners (B) (Max)	Average Weight Per Metre (Kg)	Tensile Strength KN (Min)
					IP (H1) (Max)	OP (H2) (Max)	IP (T1) (Max)	OP (T2) (Max)					
420H	D 088 01A1	12.70	6.25	7.75	11.64	10.65	2.00	2.00	3.97	16.70	17.90	0.747	17.85
520H	D 105 01 A3	15.88	6.35	10.16	14.56	13.59	2.40	2.40	5.08	18.90	20.20	1.094	32.36
50H	D 102 01 A1	15.88	9.40	10.16	14.56	13.59	2.40	2.40	5.08	22.10	23.50	1.211	32.36
525H	D 104 01 A1	15.88	7.94	10.16	14.56	13.59	2.40	2.40	5.08	20.50	21.8	1.151	32.36

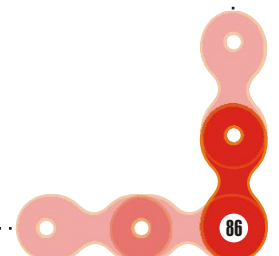

AUTOMOTIVE CHAINS

ENGINE MECHANISM CHAINS (CAM CHAINS)

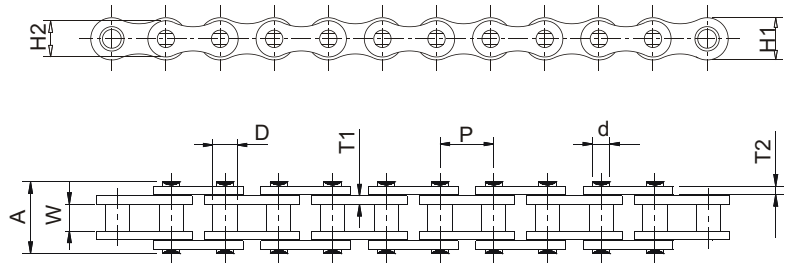

Rombo Cam chains are designed for excellent wear resistance and smooth transmission with minimal noise even under high RPM.

CAM CHAINS

Intl. Ref. No.	ROMBO Chain No.	No. of Strands	Pitch (P)	Width between Inner Plates (W) (Min)	Roller Diameter (D) (Max)	Plate Height		Plate Thickness		Bearing Pin Diameter (D) (Max)	Width Over Bearing Pin (A) (Max)	Transverse Pitch (P1)	Average Weight Per Metre (Kg)	Tensile Strength (KN) (Min)
						IP (H1) (Max)	OP (H2) (Max)	IP (T1) (Max)	OP (T2) (Max)					
25	B 04A 01	1	6.35	3.18	3.30	5.80	5.20	0.75	0.75	2.31	7.80	-	0.14	3.63
*25SH	B 04D 01	1	6.35	3.18	3.30	5.80	5.80	1.00	1.00	2.00	9.00	-	0.22	3.92
25H	B 04H 01	1	6.35	3.18	3.30	5.80	5.20	1.00	1.00	2.31	9.00	-	0.17	4.81
25HT	B 04G 01	1	6.35	3.18	3.30	5.80	5.20	1.00	1.00	2.31	9.00	-	0.17	4.81
25HT	B 04T 01	1	6.35	3.18	3.30	5.80	5.20	1.00	1.00	2.00	9.00	-	0.19	3.92
25T-2	B 04A 02	2	6.35	3.18	3.30	5.80	5.20	0.75	0.75	2.31	14.42	6.40	0.28	7.26
25-3	B 04A 03	3	6.35	3.18	3.30	5.80	5.20	0.75	0.75	2.31	20.80	6.40	0.45	12.26

WORK STANDARD CAM CHAINS

Intl. Ref. No.	ROMBO Chain No.	No. of Strands	Pitch (P)	Width between Inner Plates (W) (Min)	Roller Diameter (D) (Max)	Plate Height		Plate Thickness		Bearing Pin Diameter (D) (Max)	Width Over Bearing Pin (A) (Max)	Transverse Pitch (P1)	Average Weight Per Metre (Kg)	Tensile Strength (KN) (Min)
						IP (H1) (Max)	OP (H2) (Max)	IP (T1) (Max)	OP (T2) (Max)					
-	*B 04C 01	1	6.35	3.18	3.30	5.80	5.80	1.00	1.00	2.31	9.00	-	0.20	3.92
-	*B 04E 01	1	6.35	3.18	3.30	5.80	5.80	1.00	0.75	2.31	8.20	-	0.18	3.53
-	*B 04F 01	1	6.35	3.18	3.30	5.80	5.20	0.75	0.75	2.00	7.80	-	0.14	3.92
-	*B 04K 01	1	6.35	3.18	3.30	5.80	5.80	1.00	0.75	2.31	8.92	-	0.18	4.81
-	D 04B 01	1	6.00	2.80	4.00	4.95	4.90	0.60	0.60	1.86	7.60	-	0.12	2.94

* Straight Contour Plates



TECHNICAL
TECHNICAL
DATA

SELECTION OF ROLLER CHAIN DRIVES

The following data should be taken into consideration while selecting roller chain drives.

- a. Horsepower to be transmitted
- b. RPM of the driving and driven sprocket(Speed ratio)
- c. Load classification
- d. Space limitations if any
- e. Driven machine
- f. Source of power

If the pitch centre distance and number of teeth on both driving and driven sprockets are known, you can use the following formula, tables and charts to calculate chain lengths.

SELECTION PROCEDURE

For maximum service life, smooth operation and optimum performance, the following points should be considered, while determining the number of teeth in the pinion.

- a) As most drives have an even number of pitches in the chain, the use of a pinion with an odd number of teeth ensures even distribution of chain and wheel tooth wear.
- b) Pinions for normal, steady drives should generally not have less than 17 teeth, the reason being that a chain forms a polygon around the pinion. When the pinion speed is constant, the chain speed is subject to a regular cyclic variation. The percentage of cyclic variation becomes less marked as the number of teeth increases - and in fact becomes insignificant for the majority of applications when the number of teeth in the pinion exceeds 17.
- c) A minimum of 23 teeth is recommended on moderate shock drives where the speed of the pinion exceeds 50 % of the maximum rated speed, and for heavy shock drives where the speed of the pinion exceeds 25% of the maximum rated speed.
- d) The pinion should be heat treated to HV 10 - 550 for smooth drives where the pinion speeds exceeds 70 % of the maximum speed and operates under full horsepower rating. For heavy shock drives, the pinion should be treated in all cases.

DETERMINE THE CLASS OF LOAD

If shock loads are expected, then first determine the class of load on the basis of the drives equipment (see table 1).

LOAD CLASSIFICATIONS		TABLE 1
UNIFORM LOAD	MODERATE SHOCK LOAD	HEAVY SHOCK LOAD
Centrifugal pumps, Agitator for liquids, Conveyors, Fans-Uniform load	Reciprocating pumps, Wood working M/c's Grinders, Conveyors-Irregular load	Presses, Earth moving equipment Shears, Cranes & Hoists, Reciprocating and Shaker type conveyors, Crushers, Reciprocating feeders
Generators, M/c's all types with uniform non - reversing loads	Mixers and Machines all types with moderate shock and non-reversing loads	Machines-all types with severe impact shock loads or variation and reversing service

Note : If table 1 does not list your equipment, go by its similarity to a listed item

SELECTION OF ROLLER CHAIN DRIVES

ESTABLISH THE DESIGN HORSEPOWER

Establish the design horsepower by multiplying the specified horsepower value with the service factor given in Table 2.

SERVICE FACTOR		TABLE 2	
Type of Driven Load	TYPE OF INPUT POWER		
	Internal Combustion Engine with Hydraulic Drive	Electric Motor or Turbine	Internal Combustion Engine with Mechanical Drive
Uniform	1.0	1.0	1.2
Moderate Shock	1.2	1.3	1.4
Heavy Shock		1.4	1.5 1.7

MULTIPLE STRAND FACTOR		TABLE 3
No. of Strands	Multiple Strand Factor	
2	1.7	
3	2.5	
4	3.3	
5	3.9	
6	4.6	
8	6.2	
10	7.5	

FINAL SELECTION OF CHAIN

Selection of multi-strand chains will become necessary if available space is limited or high speeds call for a chain with lower pitch. The strand factors are given in Table 3. To facilitate selection of multi-strand chains, multiply the horsepower rating for single strand chains by the corresponding strand factor.

ISO 10823 - 1996 standard of guidance can be referred for selection of chain drive power.

Actual power = Input power x service factor x strand factor.

Considering the actual power and rpm of the pinion, using the horsepower rating chart select the chain for the application.

SELECT THE LARGE SPROCKET

By using the required shaft speed ratio select the number of teeth in the large sprocket. If the required shaft speed ratio cannot be obtained with a standard sprocket, increase the number of teeth in the small sprocket by one or two, to obtain an acceptable speed ratio with a slightly larger standard sprocket. The size of the large sprocket is affected by the allowable wear elongation of the chain which may go up to 3%. The use of sprockets with more than 67 teeth reduces the life of the chain expressed in percentage elongation as:

Permissible wear elongation = $200 / N$ (%). The speed ratio for a single drive should be not exceed 10:1. A greater ratio will make it necessary to provide for two drives in series.

DETERMINE CHAIN LENGTH

Compute the length of chain required using the formula given below. If possible, adjust the centre distance, so that the length of chain required is always in an even number of pitches. For optimum life of the chain and sprockets the centre distance between the two sprockets should be 30 to 50 times the chain pitch.

$$L = \frac{2C}{P} + \left\{ \frac{N+n}{2} \right\} + \left\{ \frac{N-n}{2\pi} \right\}^2 \frac{P}{C}$$

Where L = Chain length in pitches
P = Chain Pitch
C = Contemplated centre distance
N = Number of teeth on large sprocket
n = Number of teeth on small sprocket

INSTALLATION AND MAINTENANCE OF CHAIN DRIVES

INSTALLATION

Careful and accurate installation is very essential for trouble free operation and long life. The following instructions should therefore be carefully observed.

a) Shaft Alignment

Make sure that all shafts are parallel and level. Check alignment with a spirit level. The shafts should be supported by sufficiently strong bearings to avoid any displacement during operation.

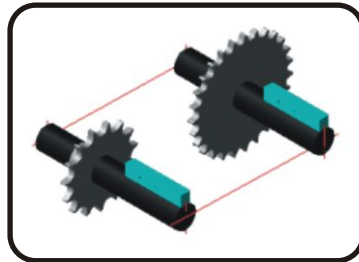

b) Installation of Sprockets

Align the sprockets exactly on the shafts. Check with a straight edge of a string held against the sides of the sprocket face. Improper alignment of sprockets will cause abnormal wear on the chain link plates and on the sides of the sprocket teeth. Check occasionally during operation for such wear.

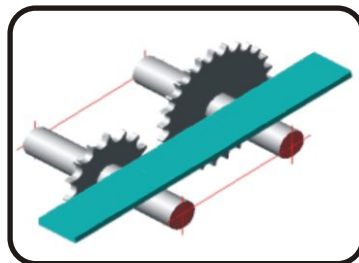

c) Mounting of Chain

Wrap the chain around the sprockets and bring the two ends together on one sprocket to connect them with a connecting link.

d) Chain Tension

The chain should never run with both sides tight. To check tension, turn one sprocket to tighten the lower span of the chain. Then measure the sag of the lower strand which should be about 2 to 3% of the tangent to the sprockets. In an inclined drive the sag should be less. In vertical drives a chain tensioner must be provided for.

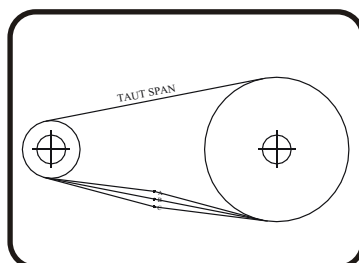

LUBRICATION OF CHAIN DRIVES

Chain life will vary appreciably depending on the way the drive is lubricated. A properly lubricated chain can last more than 100 times as long as the same chain with poor lubrication. A good grade of clean petroleum oil without additives, free flowing at the prevailing temperatures should be used. Some additives leave a varnish or gum deposit which prevents the oil from entering chain joints. Heavy oils and greases are generally too stiff to enter the chain joints and should not be used or it should be heated up indirectly and chain should be immersed in molten bath.

With proper lubrication, a separating wedge of lubricant is formed between the pins and bushings in the chain joints, much like that formed in journal bearings. The viscosity of the lubricant greatly affects its separating force and its ability to become a wedge between moving parts. The highest viscosity oil which will flow between the chain link plates and fill the pin bushing areas will provide the best wear life. This is essential to minimise metal to metal contact and, if supplied in sufficient volume, the lubricant also provides effective cooling and impact dampening at higher speeds.

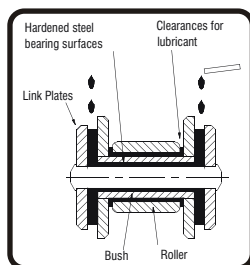
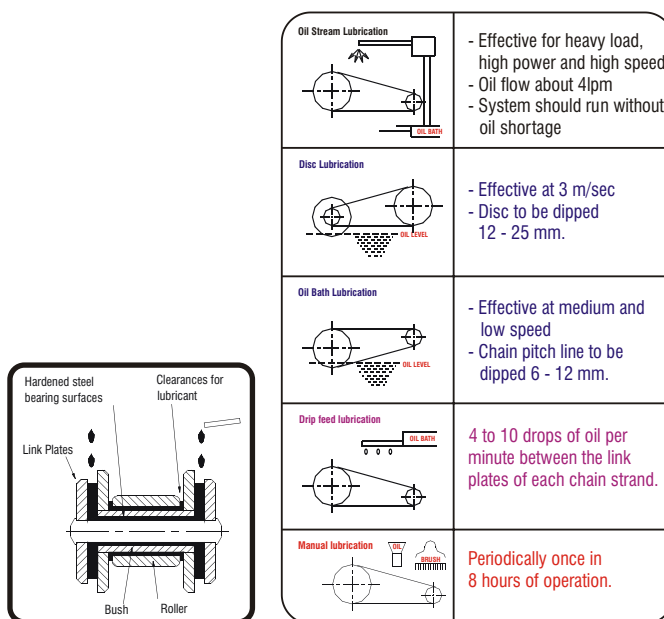

Lubrication Chart

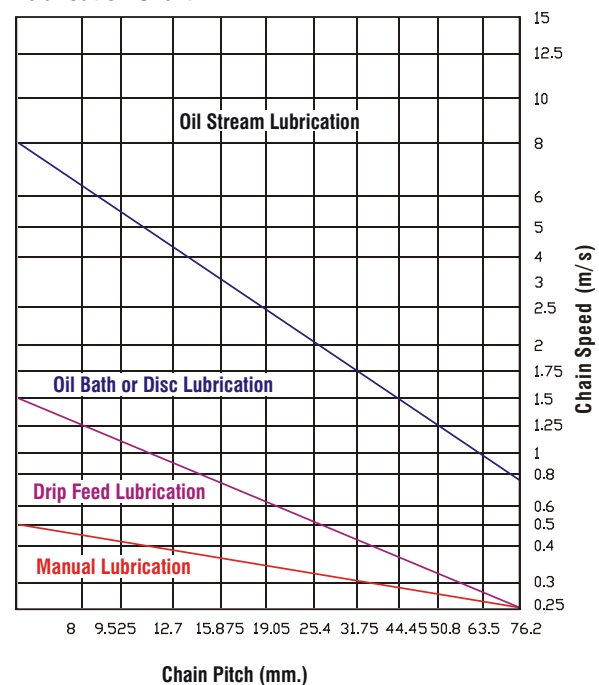

LUBRICANT



The best lubricant for most applications is a light petroleum oil. High viscosity oil and grease are suitable only for slow drives exposed to weather conditions.

The lubricant recommended by TI Diamond for the various surrounding temperatures are indicated in the following table :

Chain Pitch	- 10 degree C to 0 degree C	0 degree C to 40 degree C	40 degree C to 50 degree C	50 degree C to 60 degree C
Less than 5/8"	SAE 10	SAE 20	SAE 30	SAE 40
3/4" - 1"	SAE 20	SAE 30	SAE 40	SAE 50
1 1/4 "				
1 1/2 " & ABOVE	SAE 30	SAE 40	SAE 50	

Chain drives should be protected from dust, dirt and moisture. Depending on the type of application and type of lubrication, system should be cleaned and oil change is recommended after the first 500 operating hours, to be repeated every 2500 hours.

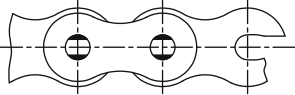
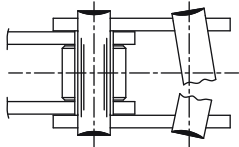
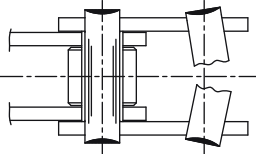
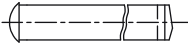
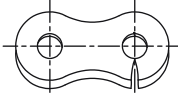
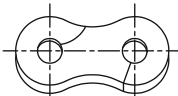
TROUBLE SHOOTING HINTS

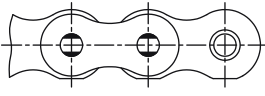
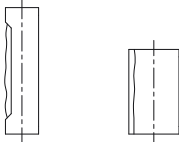
PROBLEM	POSSIBLE CAUSES OF PROBLEM	SUGGESTED REMEDY
 Fracture Plate	Overloading	Inspect the drive to determine the cause of high load and eliminate Or Redesign drive for larger pitch chain
 Broken Pins	Overloading	Inspect the drive to determine the cause of high load and eliminate or Redesign drive for larger pitch chain
 Broken Pins (Centre)	Loading is greater than pin's dynamic capacity	Inspect the drive to determine the cause of high load and eliminate or Redesign drive for larger pitch chain
 Broken Pins (Offset Pin)	Overloading	Redesign drive using a higher capacity chain
 Fatigue Failure	Loading is greater than chain's dynamic capacity	Single pitch offset link is to be eliminated Redesign drive using a higher capacity chain
 Cracking	Stress corrosion cracking	Inspect the drive to determine the cause of high load and eliminate Select anti-corrosive chain
 Broken Roller	Speed too high Sprockets too small Chain riding too high on sprocket teeth	Replace chain, reduce speed Use larger sprockets or possibly redesign drive for small sprocket
 Worn Contour	Chain rubbing on casing, guide or obstruction	Replace chain if 5% or more height worn out Inspect and redesign casing, guide and eliminate interference
 Pin or Bushing Galling	Speed or load too high Inadequate lubrication	Reduce speed or load Redesign drive for smaller pitch chain Provide proper lubrication system

HORSEPOWER RATING CHART

**TENTATIVE SELECTION CHART FOR AMERICAN STANDARD CHAINS
(19 TEETH PINION)**

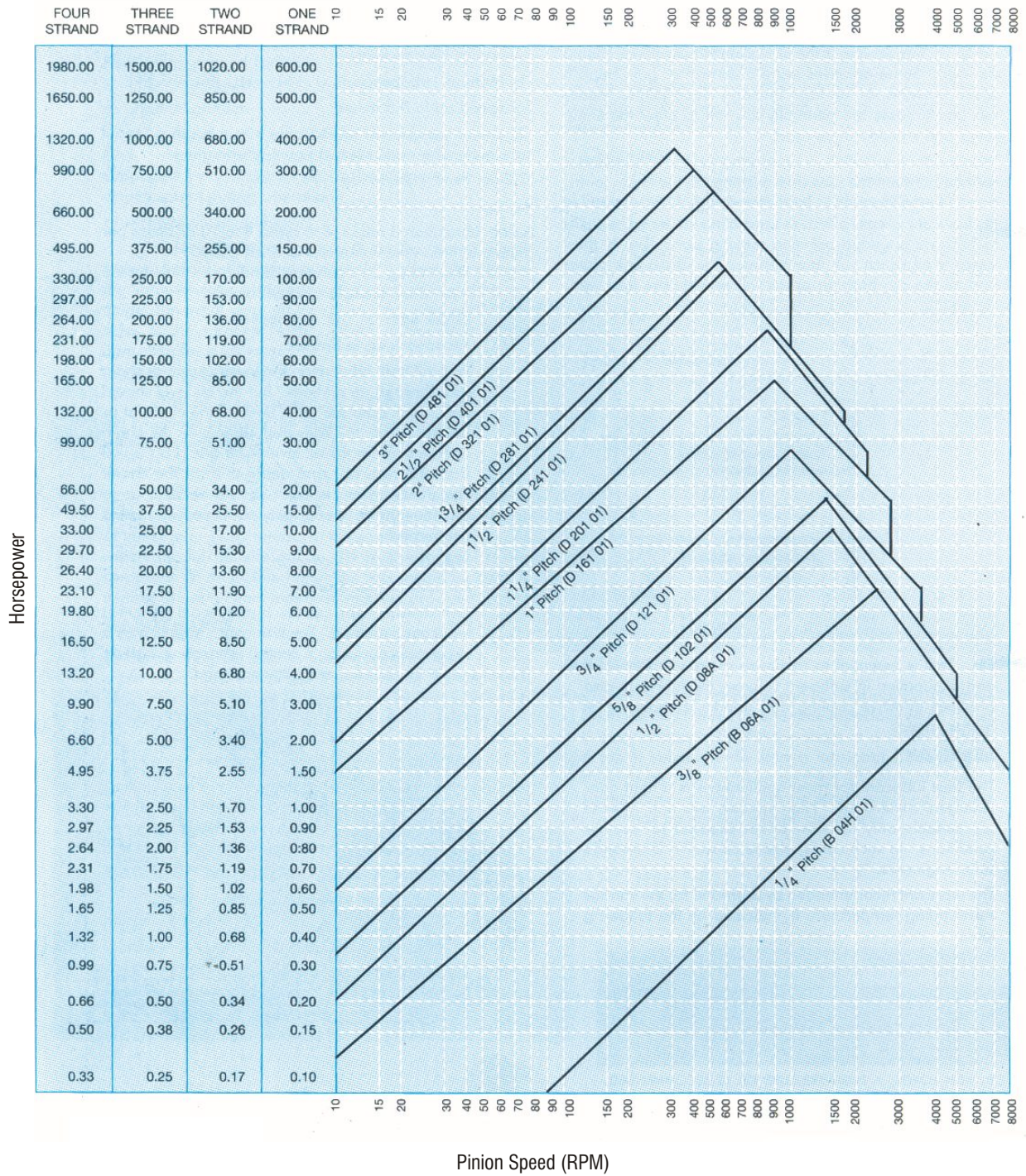

HORSEPOWER RATING CHART

**TENTATIVE SELECTION CHART FOR BRITISH STANDARD CHAINS
(19 TEETH PINION)**

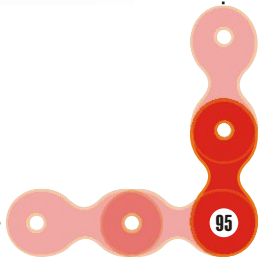
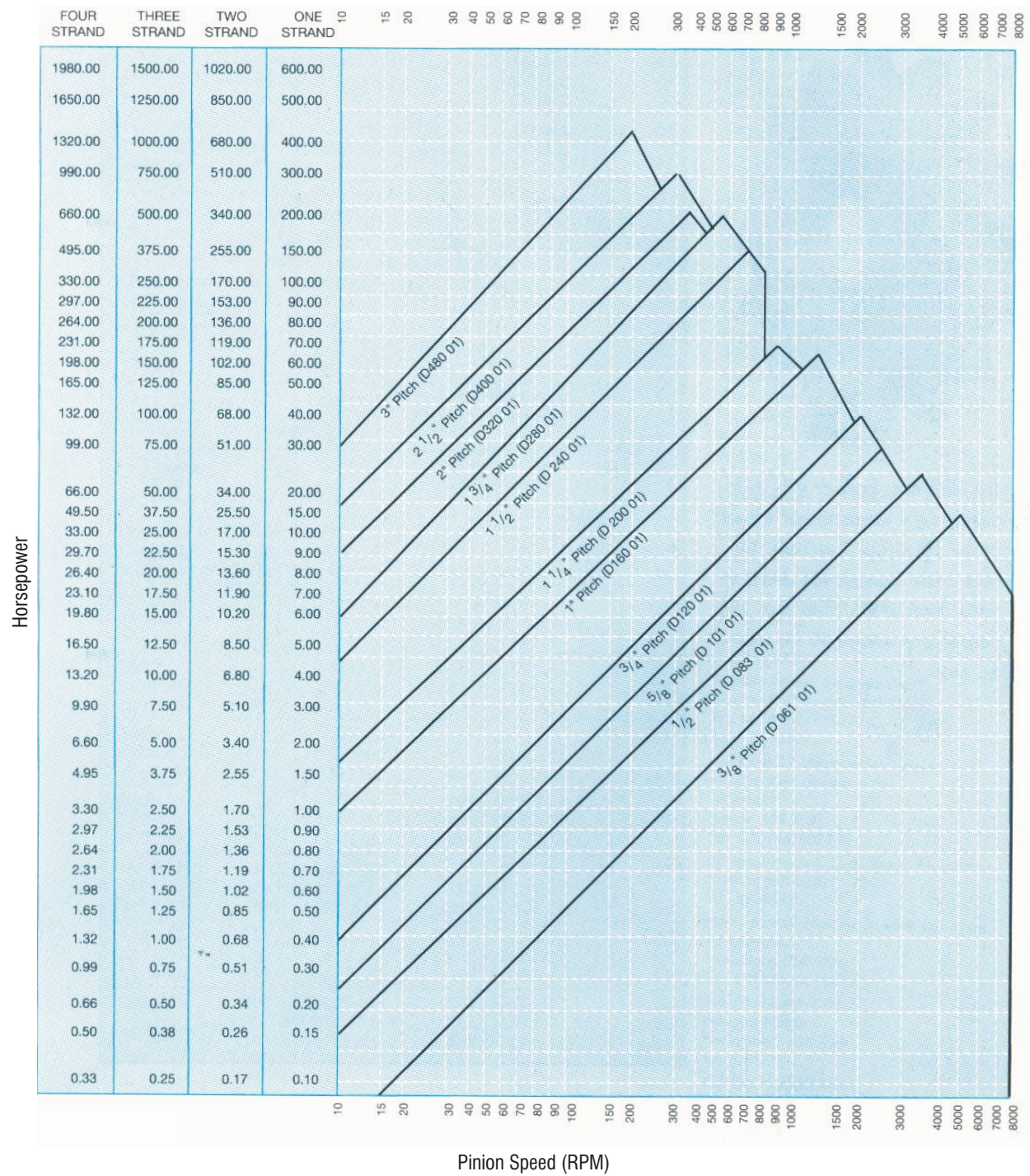

WARNING

Comply with the following to avoid serious personal injury and critical accidents.

- Guards must be provided on all chain and sprocket installation as per ANSI / ASME B 15.1 - 1984 and ANSI / ASME B 20.1 1990 or other applicable safety standards. As and when these standards are revised, the updated edition should be followed.
- Power should be switched off before installation, removal, lubrication or service of a chain system.
- When connecting or disconnecting chain
 - Wear safety glasses, protective clothing, gloves and safety shoes
 - Support the chain to prevent movement
 - Use appropriate tools for connecting and disconnecting chains and sprockets
- Do not attempt to connect or disconnect chain unless the drive mechanism is well understood.
- Chain and sprocket selection should be made in accordance with our horsepower rating chart or our Recommendations.
- Regular maintenance is required for all chain drives.
- Connecting link should be attached as illustrated.

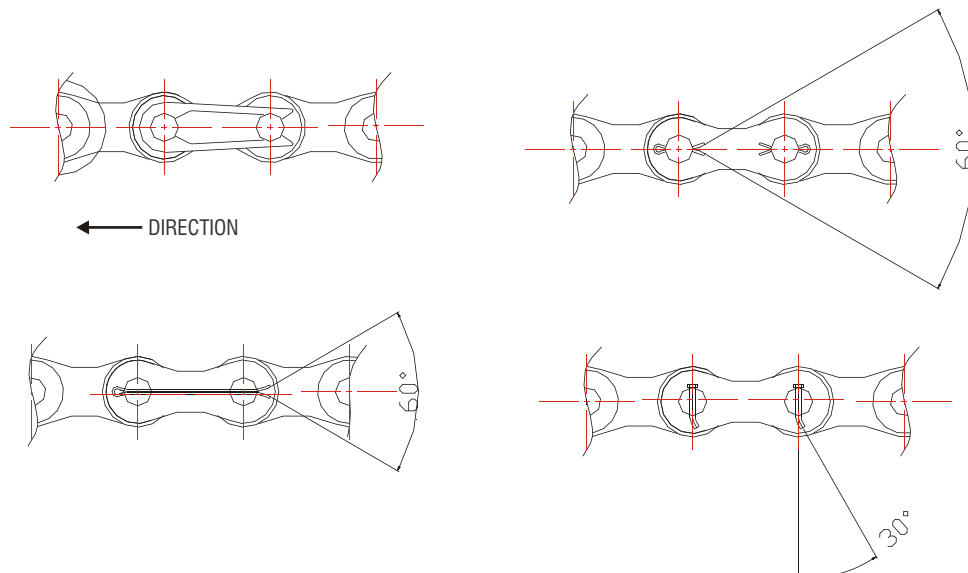

- Plating, welding and other operations may reduce strength and can cause breakage. Consult our engineers for recommendation.
- Do not re-use disassembled chain parts. Do not use reworked chain or join reworked chain with a new chain.
- Never use acid, alkali or general rust removal solvents to clean a chain. It may cause Hydrogen embrittlement.
- Never use a new chain on an old sprocket. Replace chains and sprockets together.

**TÜV
CERT**
CERTIFICATE

The TÜV CERT Certification Body of RWTÜV Systems GmbH hereby certifies in accordance with TÜV CERT procedure that

TIDC INDIA LIMITED
Ambattur Unit - Chennai
Rolmor Chains Division, Kazipally,
Hyderabad, India

has established and applies an environmental management system for Design, Manufacture and Supply of Automotive, Industrial, Agricultural, Motor Cycle Roller and Bush Chains, Cam Chains, Engineering Class Chains, Fine Blanketing Components & Accessories

An audit was performed, Report No. ZS-1486/1999

Proof has been furnished that the requirements according to ISO 14001:1996 are fulfilled. The certificate is valid until 13 May 2007

Certificate Registration No. 04184367 IND

The company has been certified since 2001



**TÜV
CERT**
CERTIFICATE

The TÜV CERT Certification Body of RWTÜV Systems GmbH hereby certifies in accordance with TÜV CERT procedure that

TI DIAMOND CHAIN LIMITED
Ambattur Unit, Chennai
Rolmor Chains Division, Hyderabad,
India

has established and applies a quality system for Design, Manufacture and Supply of Automotive Motorcycle, Agricultural, Industrial Roller and Bush Chains, Conveyor Chains, Engineering Class Chains and Accessories

An audit was performed, Report No. ZS-178/93

Proof has been furnished that the requirements according to ISO 9001:2000 / DIN EN ISO 9001:2000 / ANSI/ASQC C9001:2000 are fulfilled. The certificate is valid until December 2005

Certificate Registration No. 041803017

The company has been certified since 1993



**TÜV
CERT**
CERTIFICATE

The TÜV CERT Certification Body of RWTÜV Systems GmbH hereby certifies in accordance with TÜV CERT procedure that

TI DIAMOND CHAIN LIMITED
Ambattur Unit, Chennai
Rolmor Chains Division, Hyderabad,
India

has established and applies a quality system for Design, Manufacture and Supply of Automotive Motorcycle, Agricultural, Industrial Roller and Bush Chains, Conveyor Chains, Engineering Class Chains and Accessories

An audit was performed, Report No. ZS-178/93

Proof has been furnished that the requirements according to ISO 9001:2000 / DIN EN ISO 9001:2000 / ANSI/ASQC C9001:2000 are fulfilled. The certificate is valid until December 2005

Certificate Registration No. 041803017

The company has been certified since 1993

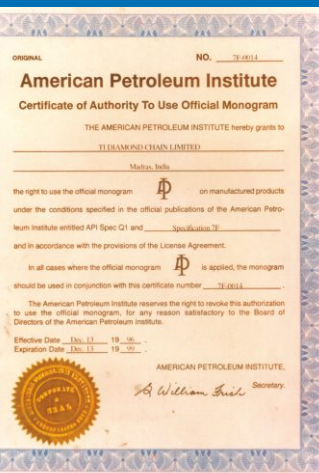

- * All dimensions indicated are in mm.
- * All information contained in this catalogue is subject to change after publication.
- * While all reasonable care has been taken in compiling the information contained in this catalogue, no responsibility is accepted for printing errors.